

# 60 MINUTE FIRE RESISTIVE GPX WALL/WINDOW WITH BUTT-GLAZED OPTION - INTERIOR APPLICATION -

For more details, please visit [www.safti.com](http://www.safti.com)

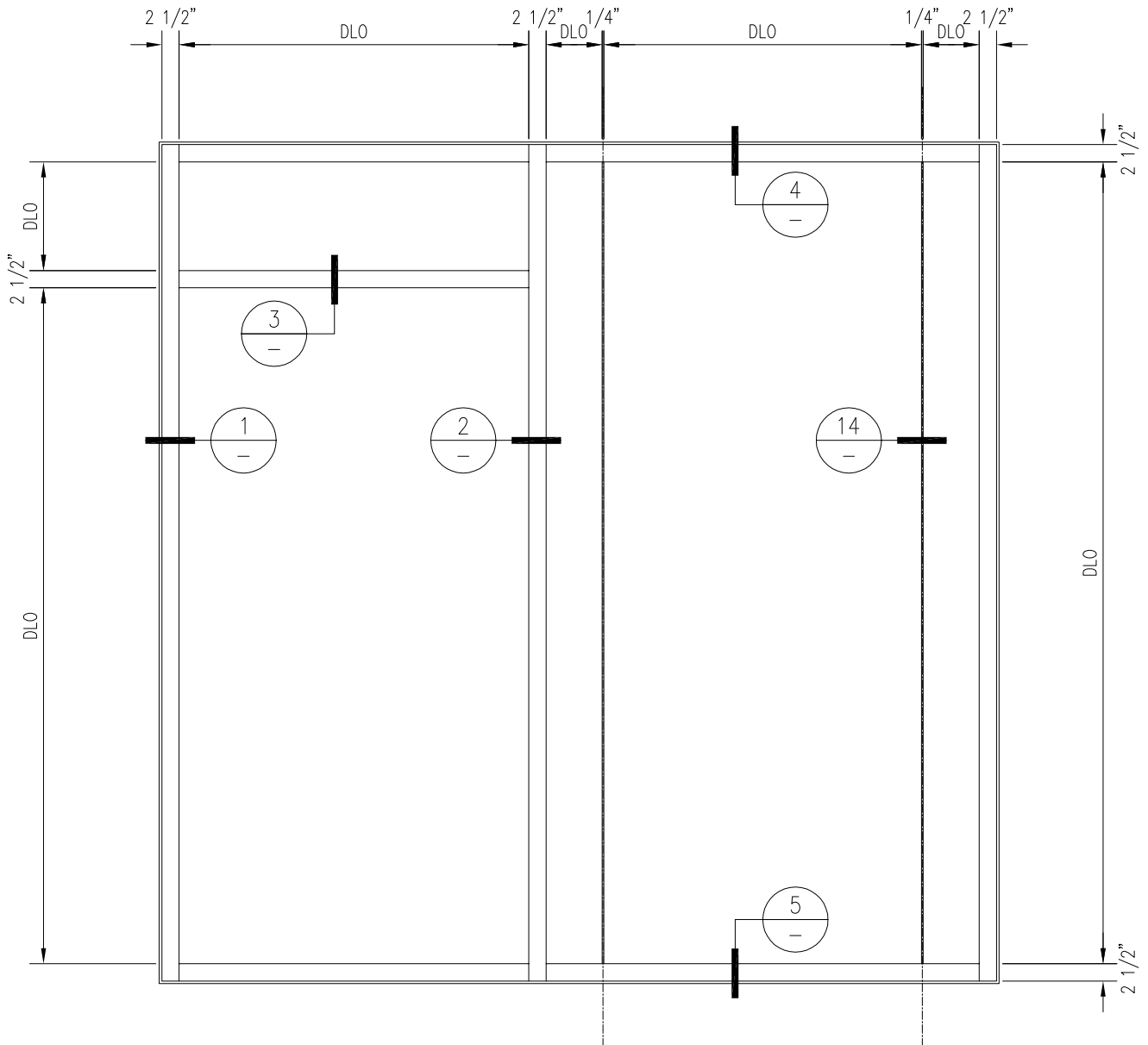

**SAFTIFIRST™**  
 FIRE RATED GLAZING SOLUTIONS *Since 1982*  
 100 N. HILL DR. SUITE 12 TEL: (415) 824-4900  
 BRISBANE, CA 94005 FAX: (415) 824-5900

**SuperLite™ III-XL**  
**GPX ARCHITECTURAL**  
**SERIES**

DATE:

DRAWN:

SCALE:

These details are subject to change without notice.

# 60 MINUTE FIRE RESISTIVE GPX WALL/WINDOW WITH BUTT-GLAZED OPTION - INTERIOR APPLICATION -

For more details, please visit [www.safti.com](http://www.safti.com)

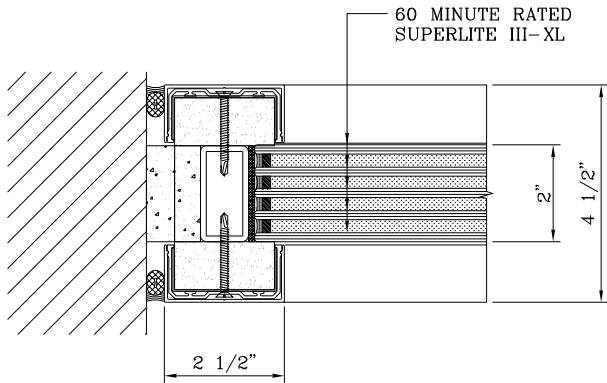

1 JAMB DETAIL

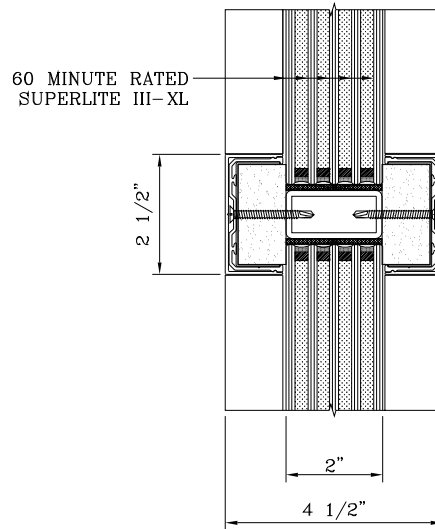

3 HORIZONTAL MULLION DETAIL

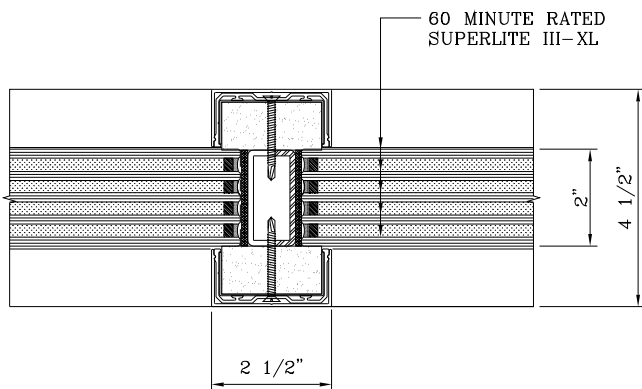

2 VERTICAL MULLION DETAIL

**SAFTIFIRST™**  
FIRE RATED GLAZING SOLUTIONS *Since 1982*  
100 N. HILL DR. SUITE 12 TEL: (415) 824-4900  
BRISBANE, CA 94005 FAX: (415) 824-5900

**SuperLite™ III-XL**  
**GPX ARCHITECTURAL**  
**SERIES**

DATE:

DRAWN:

SCALE:

These details are subject to change without notice.

# 60 MINUTE FIRE RESISTIVE GPX WALL/WINDOW WITH BUTT-GLAZED OPTION - INTERIOR APPLICATION -

For more details, please visit [www.safti.com](http://www.safti.com)

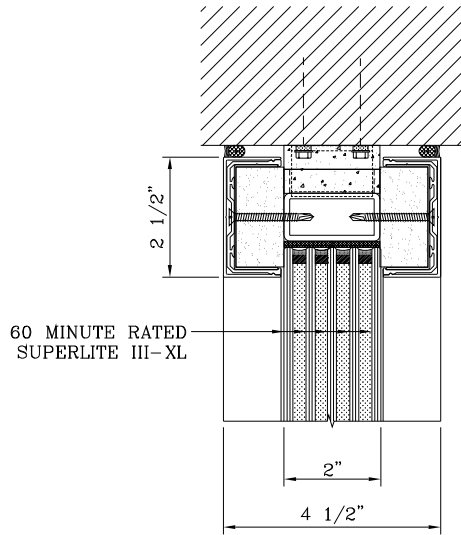

4 HEAD DETAIL

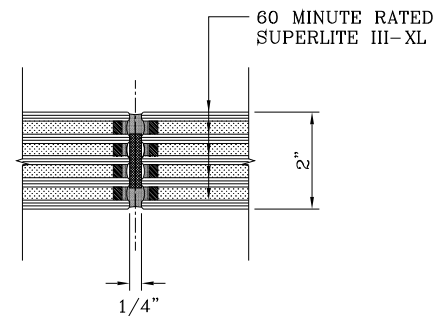

14 BUTT-GLAZED DETAIL

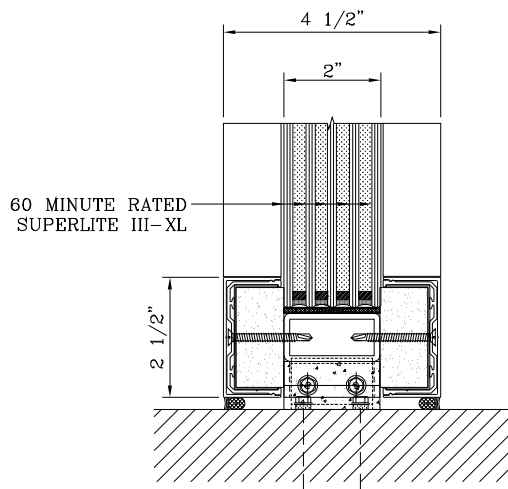

5 SILL DETAIL

**SAFTIFIRST™**  
FIRE RATED GLAZING SOLUTIONS *Since 1982*  
100 N. HILL DR. SUITE 12 TEL: (415) 824-4900  
BRISBANE, CA 94005 FAX: (415) 824-5900

**SuperLite™ III-XL**  
**GPX ARCHITECTURAL**  
**SERIES**

DATE:

DRAWN:

SCALE:

These details are subject to change without notice.