

120 MINUTE FIRE RESISTIVE BALLISTIC RATED WALL WITH 90 MINUTE FIRE RESISTIVE BALLISTIC RATED SINGLE DOORS

For more details, please visit www.safti.com

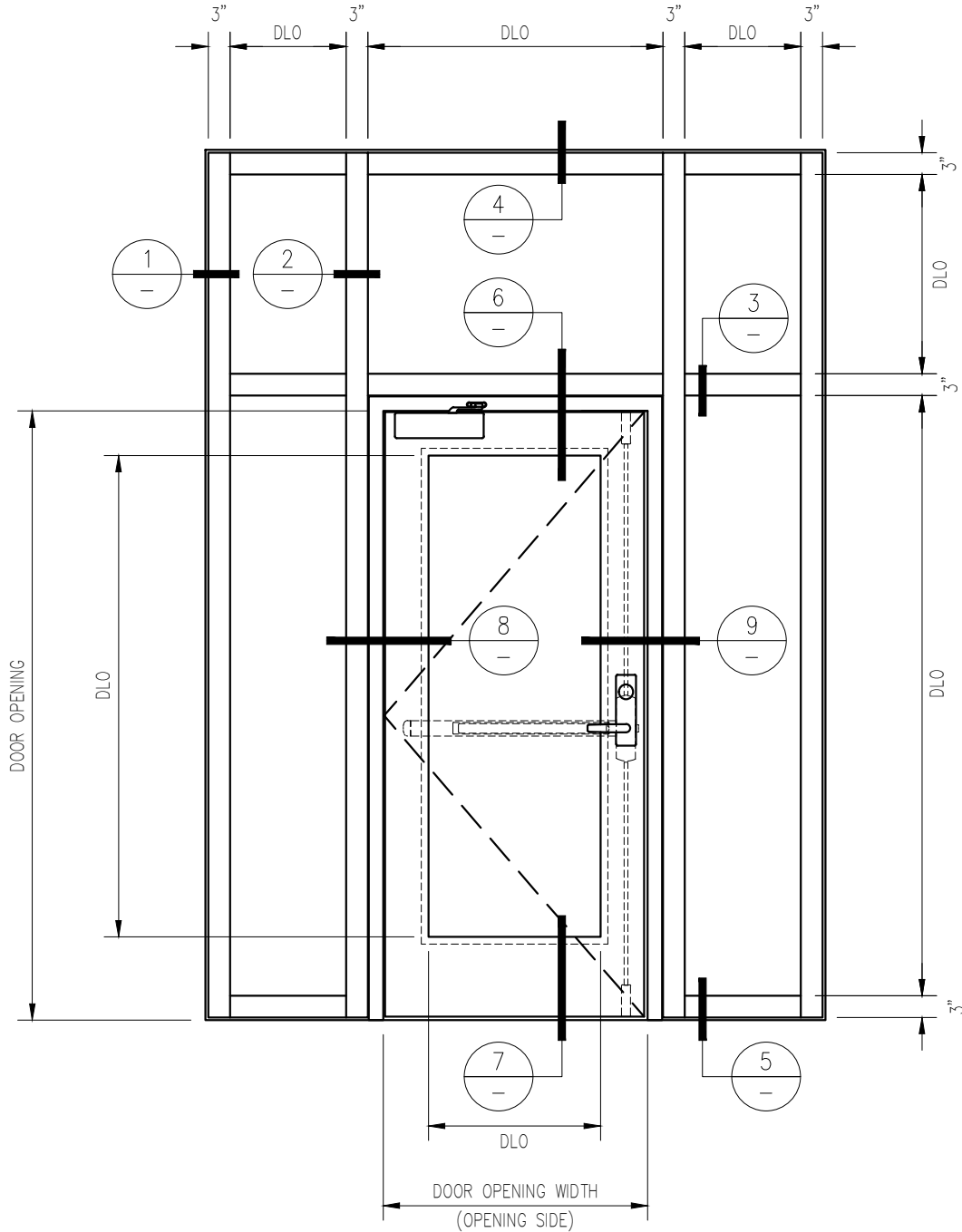

SAFTIFIRST™
 FIRE RATED GLAZING SOLUTIONS Since 1982
 100 N. HILL DR. SUITE 12 TEL: (415) 824-4900
 BRISBANE, CA 94005 FAX: (415) 824-5900

SuperLite™ II-XL
GPX BALLISTIC SYSTEM

DATE:

DRAWN:

SCALE:

These details are subject to change without notice.

120 MINUTE FIRE RESISTIVE BALLISTIC RATED WALL WITH 90 MINUTE FIRE RESISTIVE BALLISTIC RATED SINGLE DOORS

For more details, please visit www.safti.com

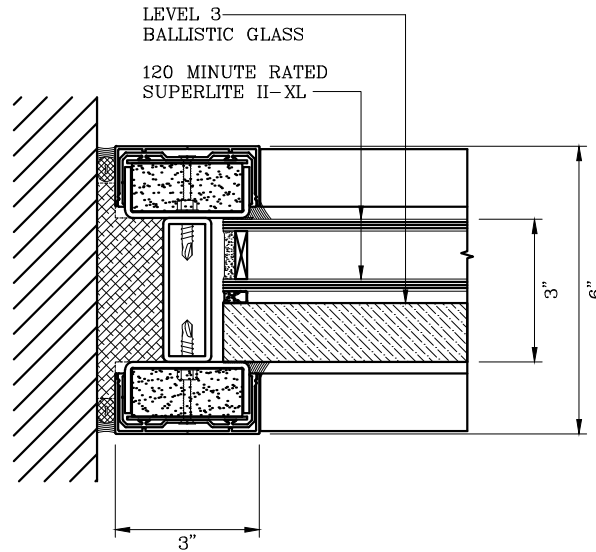

1 JAMB DETAIL

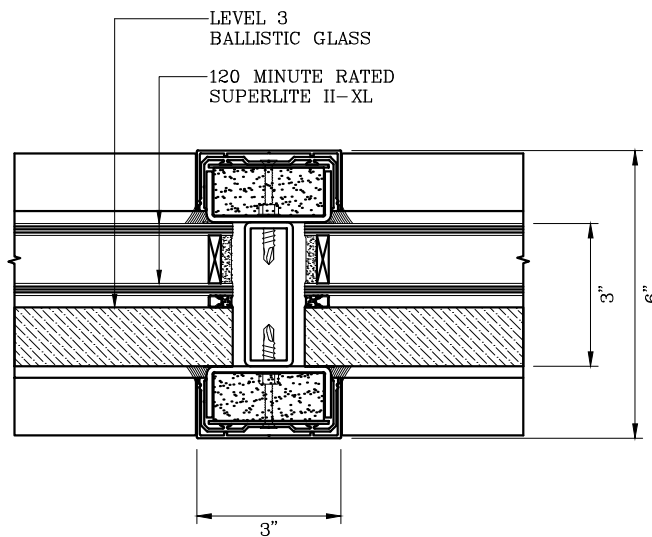

2 VERTICAL MULLION DETAIL

SAFTIFIRST™
FIRE RATED GLAZING SOLUTIONS Since 1982
100 N. HILL DR. SUITE 12 TEL: (415) 824-4900
BRISBANE, CA 94005 FAX: (415) 824-5900

SuperLite™ II-XL
GPX BALLISTIC SYSTEM

DATE:

DRAWN:

SCALE:

These details are subject to change without notice.

120 MINUTE FIRE RESISTIVE BALLISTIC RATED WALL WITH 90 MINUTE FIRE RESISTIVE BALLISTIC RATED SINGLE DOORS

For more details, please visit www.safti.com

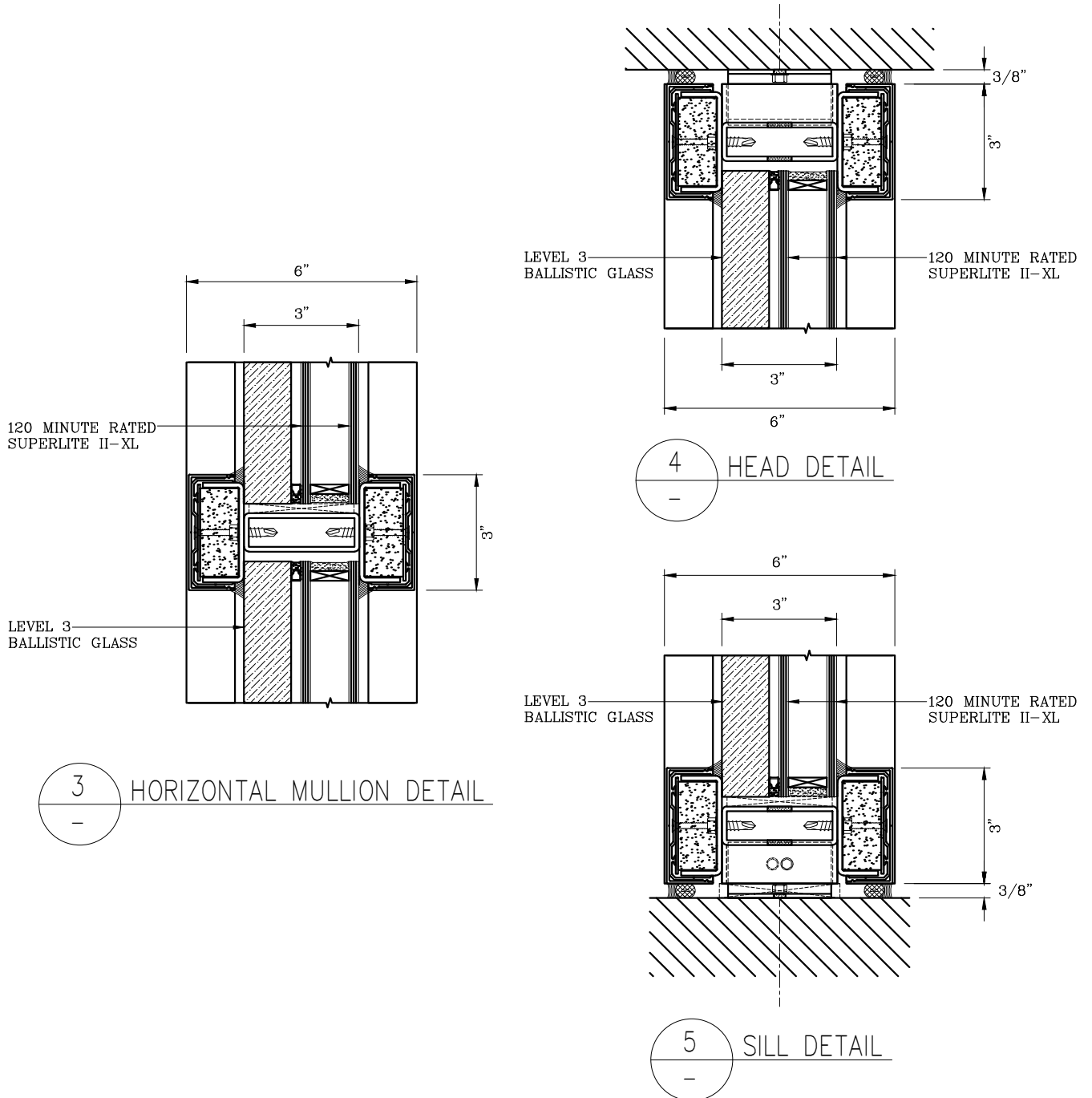

SAFTIFIRST™
 FIRE RATED GLAZING SOLUTIONS *Since 1982*
 100 N. HILL DR. SUITE 12 TEL: (415) 824-4900
 BRISBANE, CA 94005 FAX: (415) 824-5900

SuperLite™ II-XL
GPX BALLISTIC SYSTEM

DATE:

DRAWN:

SCALE:

These details are subject to change without notice.

120 MINUTE FIRE RESISTIVE BALLISTIC RATED WALL WITH 90 MINUTE FIRE RESISTIVE BALLISTIC RATED SINGLE DOORS

For more details, please visit www.safti.com

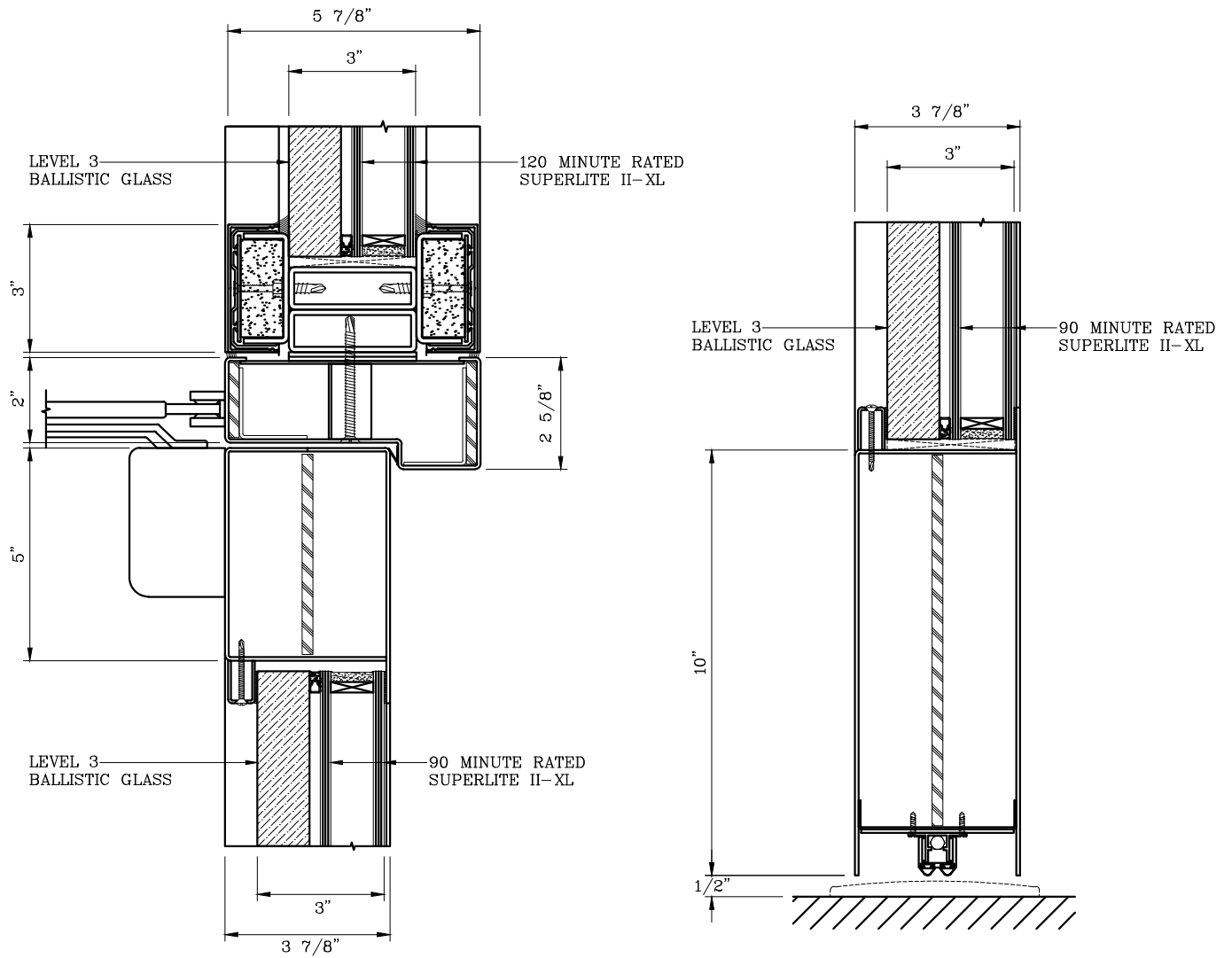

6 DOOR TOP RAIL DETAIL

7 DOOR BOTTOM RAIL DETAIL

SAFTIFIRST™
 FIRE RATED GLAZING SOLUTIONS Since 1982
 100 N. HILL DR. SUITE 12 TEL: (415) 824-4900
 BRISBANE, CA 94005 FAX: (415) 824-5900

SuperLite™ II-XL
GPX BALLISTIC SYSTEM

DATE:

DRAWN:

SCALE:

These details are subject to change without notice.

120 MINUTE FIRE RESISTIVE BALLISTIC RATED WALL WITH 90 MINUTE FIRE RESISTIVE BALLISTIC RATED SINGLE DOORS

For more details, please visit www.safti.com

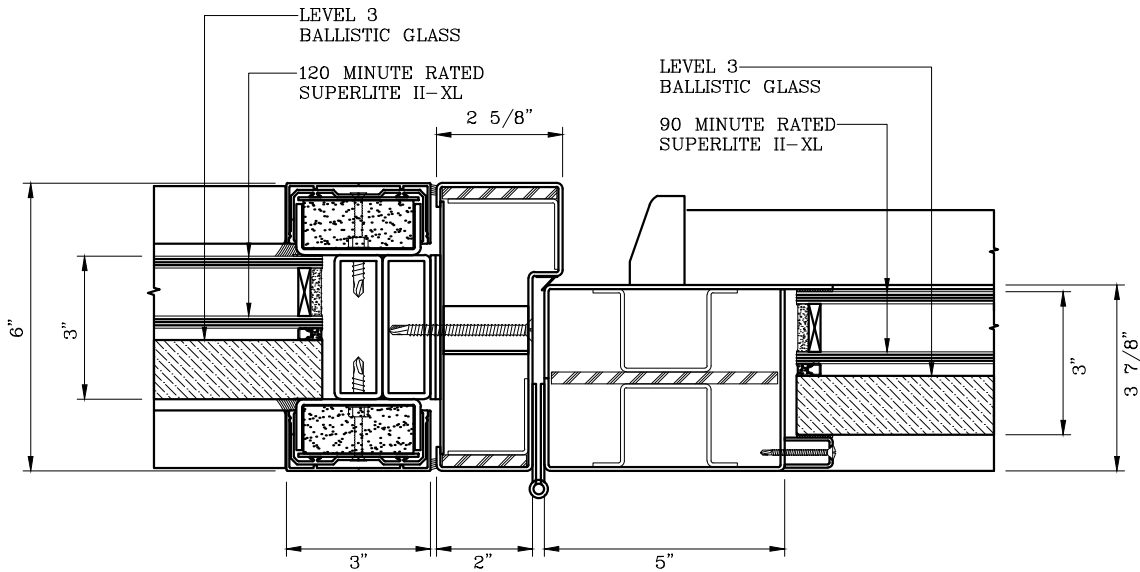

8 DOOR JAMB at HINGE DETAIL

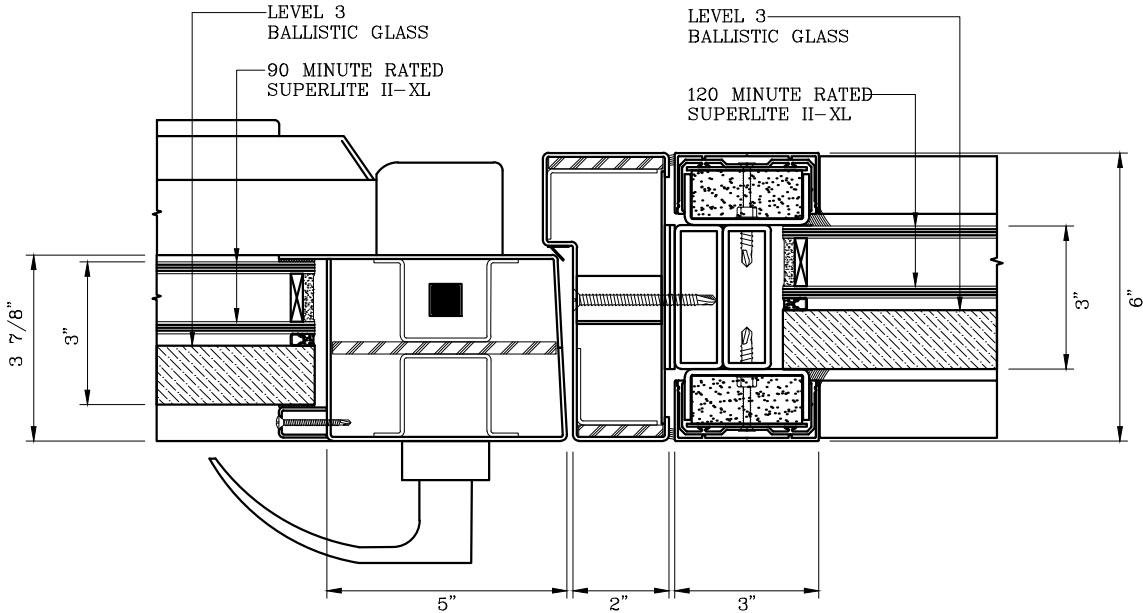

9 DOOR MEETING STILES DETAIL

SAFTIFIRST™
FIRE RATED GLAZING SOLUTIONS Since 1982
100 N. HILL DR. SUITE 12 TEL: (415) 824-4900
BRISBANE, CA 94005 FAX: (415) 824-5900

SuperLite™ II-XL
GPX BALLISTIC SYSTEM

DATE:

DRAWN:

SCALE:

These details are subject to change without notice.