

60 MINUTE FIRE RESISTIVE CURTAIN WALL WITH 60 MINUTE FIRE RESISTIVE GPX SINGLE DOOR — FOR SPANS OVER 14 FEET —

For more details, please visit www.safti.com

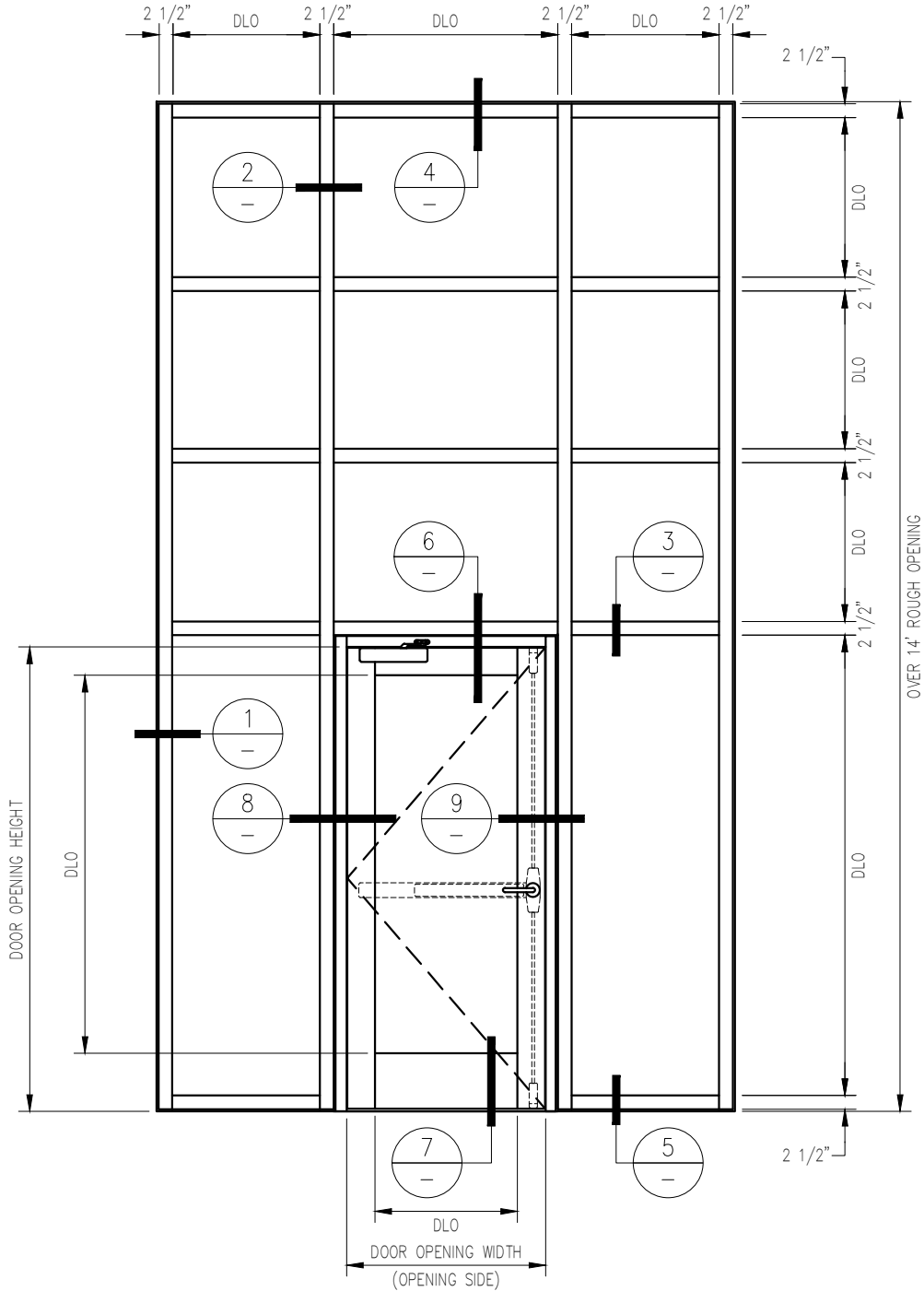

SAFTIFIRST™
FIRE RATED GLAZING SOLUTIONS *Since 1982*
100 N. HILL DR. SUITE 12 TEL: (415) 824-4900
BRISBANE, CA 94005 FAX: (415) 824-5900

SuperLite™ II-XL
GPX CURTAIN WALL SYSTEM

DATE:

DRAWN:

SCALE:

These details are subject to change without notice.

60 MINUTE FIRE RESISTIVE CURTAIN WALL WITH 60 MINUTE FIRE RESISTIVE GPX SINGLE DOOR — FOR SPANS OVER 14 FEET —

For more details, please visit www.safti.com

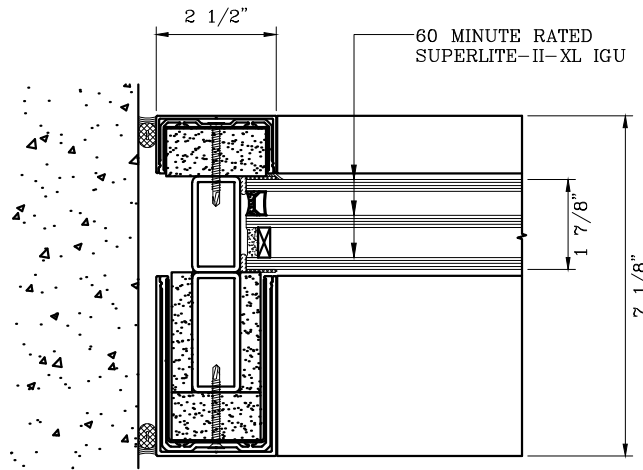

1 JAMB DETAIL

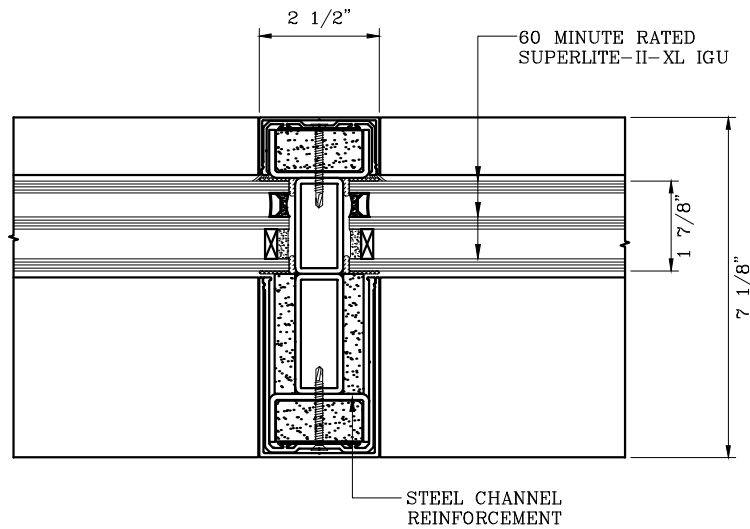

2 VERTICAL MULLION DETAIL

SAFTIFIRST™
FIRE RATED GLAZING SOLUTIONS *Since 1982*
100 N. HILL DR. SUITE 12 TEL: (415) 824-4900
BRISBANE, CA 94005 FAX: (415) 824-5900

SuperLite™ II-XL
GPX CURTAIN WALL SYSTEM

DATE:

DRAWN:

SCALE:

These details are subject to change without notice.

60 MINUTE FIRE RESISTIVE CURTAIN WALL WITH 60 MINUTE FIRE RESISTIVE GPX SINGLE DOOR — FOR SPANS OVER 14 FEET —

For more details, please visit www.safti.com

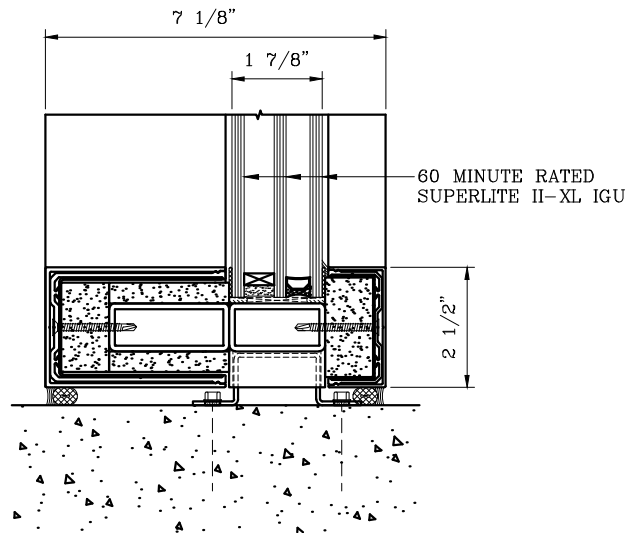
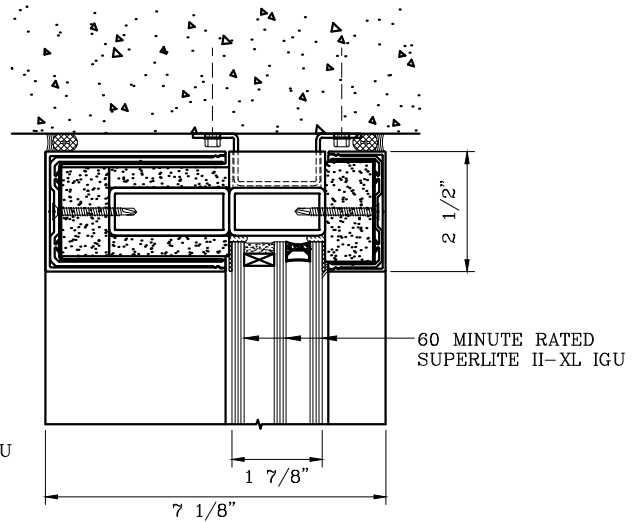
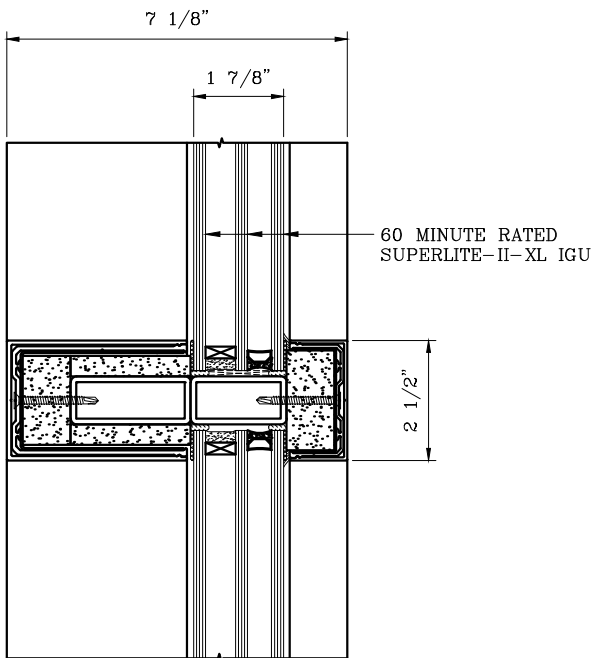

SAFTIFIRST™
FIRE RATED GLAZING SOLUTIONS *Since 1982*
100 N. HILL DR. SUITE 12 TEL: (415) 824-4900
BRISBANE, CA 94005 FAX: (415) 824-5900

SuperLite™ II-XL
GPX CURTAIN WALL SYSTEM

DATE:

DRAWN:

SCALE:

These details are subject to change without notice.

60 MINUTE FIRE RESISTIVE CURTAIN WALL WITH 60 MINUTE FIRE RESISTIVE GPX SINGLE DOOR — FOR SPANS OVER 14 FEET —

For more details, please visit www.safti.com

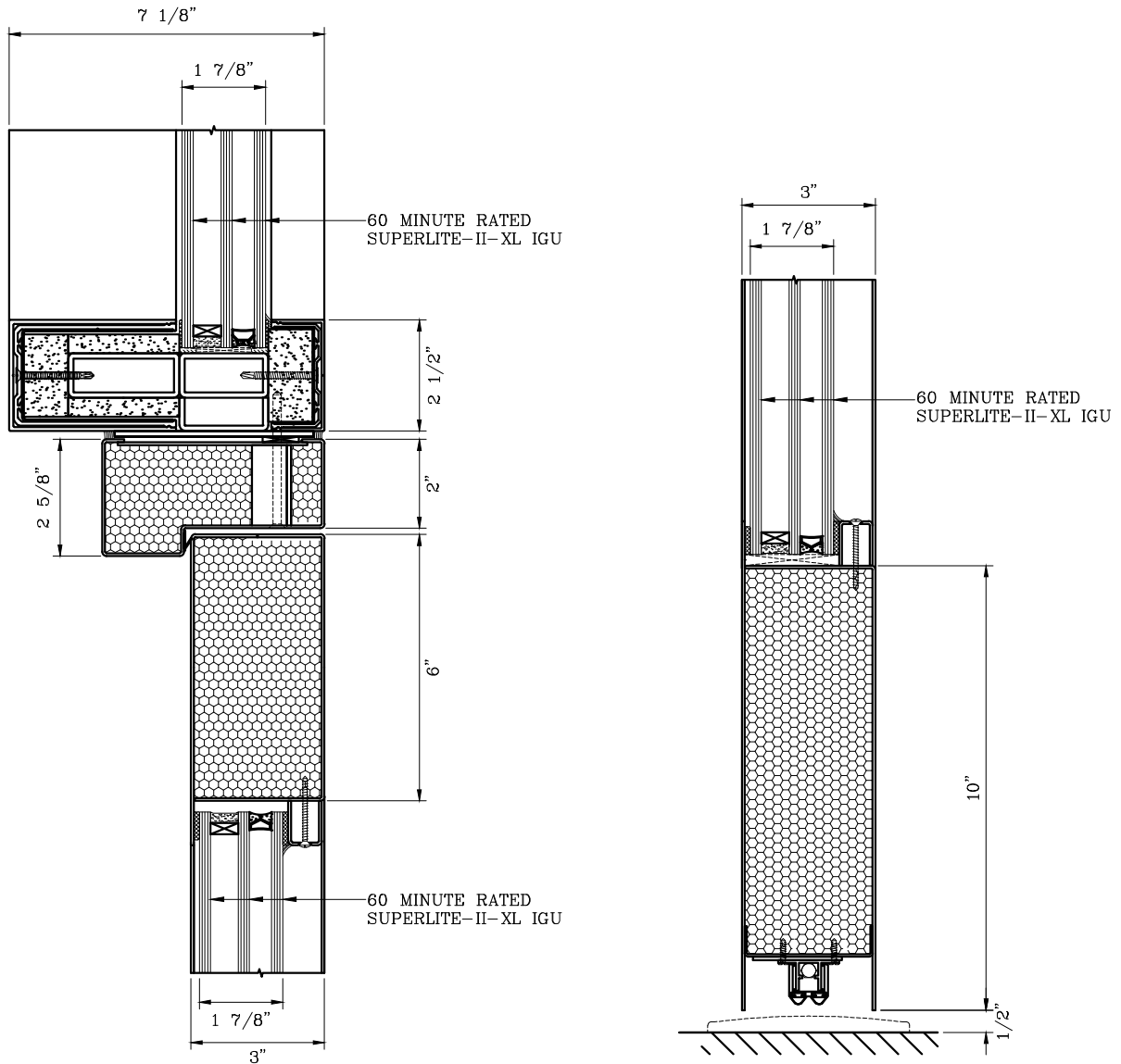

6 DOOR TOP RAIL DETAIL

7 DOOR BOTTOM RAIL DETAIL

SAFTIFIRST™
 FIRE RATED GLAZING SOLUTIONS *Since 1982*
 100 N. HILL DR. SUITE 12 TEL: (415) 824-4900
 BRISBANE, CA 94005 FAX: (415) 824-5900

SuperLite™ II·XL
GPX CURTAIN WALL SYSTEM

DATE:

DRAWN:

SCALE:

These details are subject to change without notice.

60 MINUTE FIRE RESISTIVE CURTAIN WALL WITH 60 MINUTE FIRE RESISTIVE GPX SINGLE DOOR — FOR SPANS OVER 14 FEET —

For more details, please visit www.safti.com

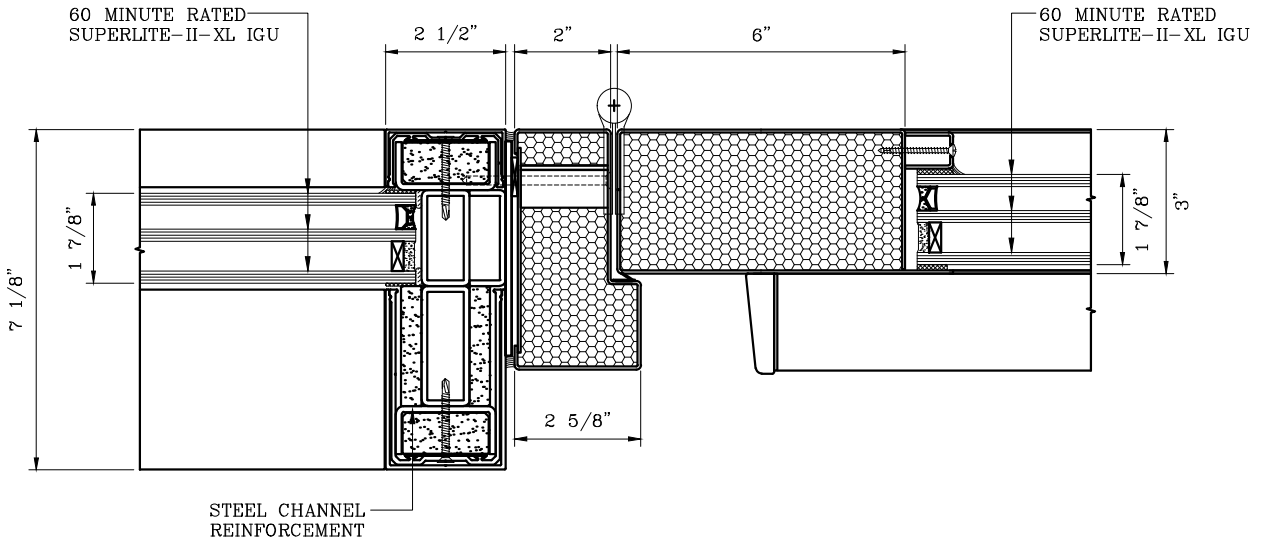

8 DOOR JAMB at HINGE DETAIL

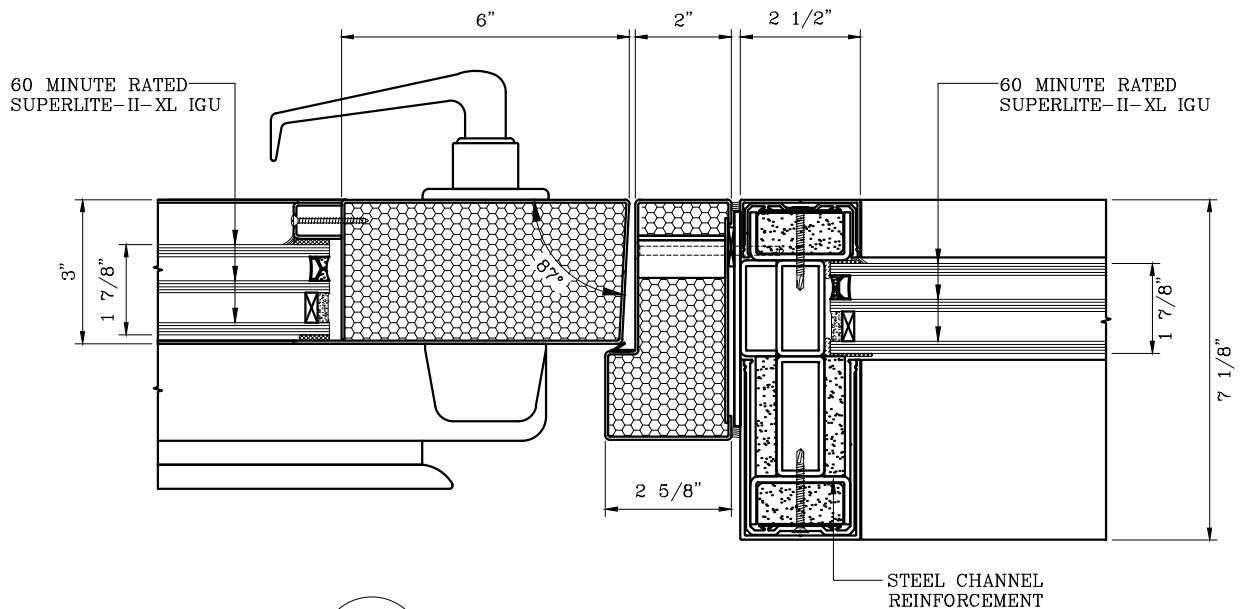

9 DOOR MEETING STILES DETAIL

SAFTIFIRST™
FIRE RATED GLAZING SOLUTIONS Since 1982
100 N. HILL DR. SUITE 12 TEL: (415) 824-4900
BRISBANE, CA 94005 FAX: (415) 824-5900

SuperLite™ II-XL
GPX CURTAIN WALL SYSTEM

DATE:

DRAWN:

SCALE:

These details are subject to change without notice.