

90 MINUTE FIRE RESISTIVE HURRICANE RATED SINGLE DOOR

For more details, please visit www.safti.com

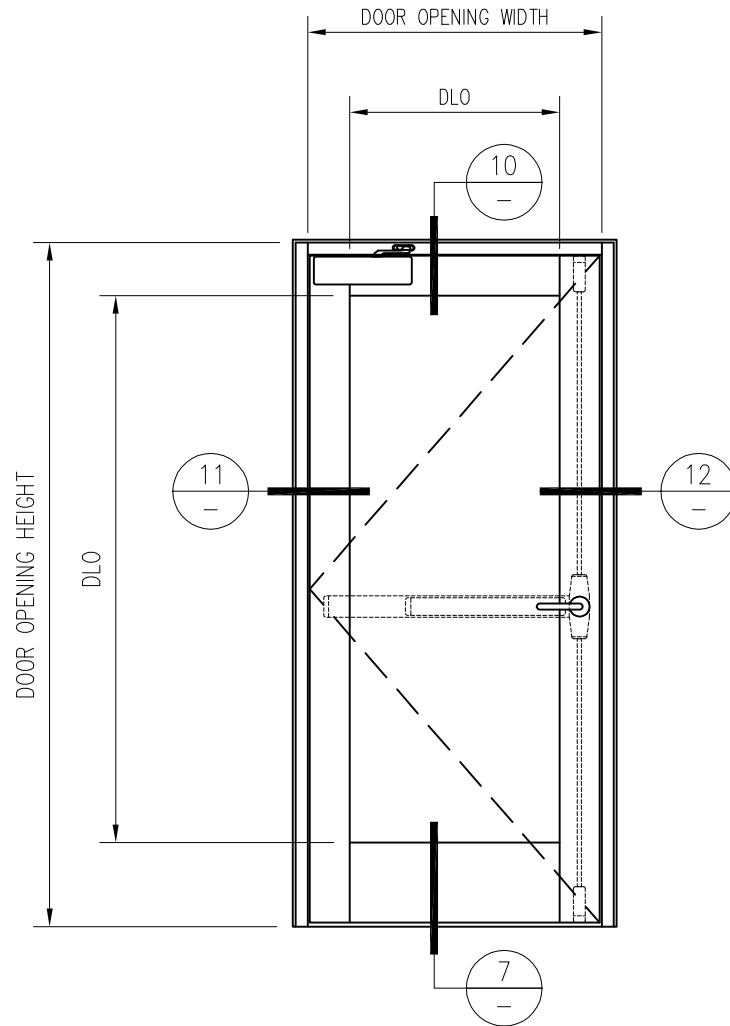

SAFTIFIRST™
FIRE RATED GLAZING SOLUTIONS *Since 1982*
100 N. HILL DR. SUITE 12 TEL: (415) 824-4900
BRISBANE, CA 94005 FAX: (415) 824-5900

SuperLite™ II-XL
GPX HURRICANE SYSTEM

DATE:

DRAWN:

SCALE:

These details are subject to change without notice.

90 MINUTE FIRE RESISTIVE HURRICANE RATED SINGLE DOOR

For more details, please visit www.safti.com

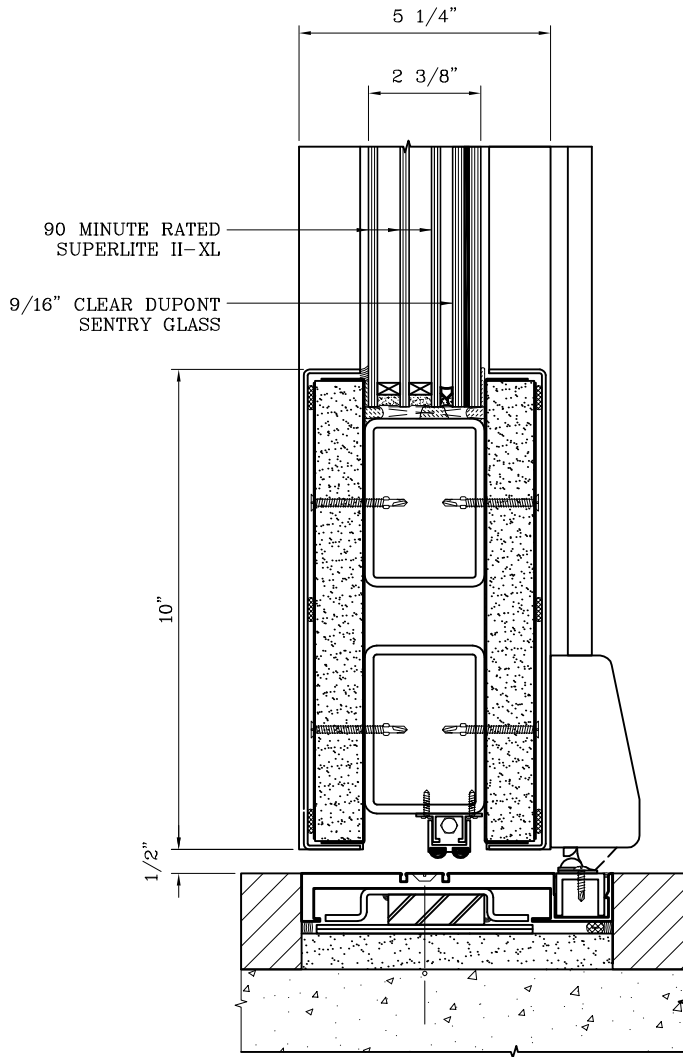

7 DOOR BOTTOM RAIL DETAIL

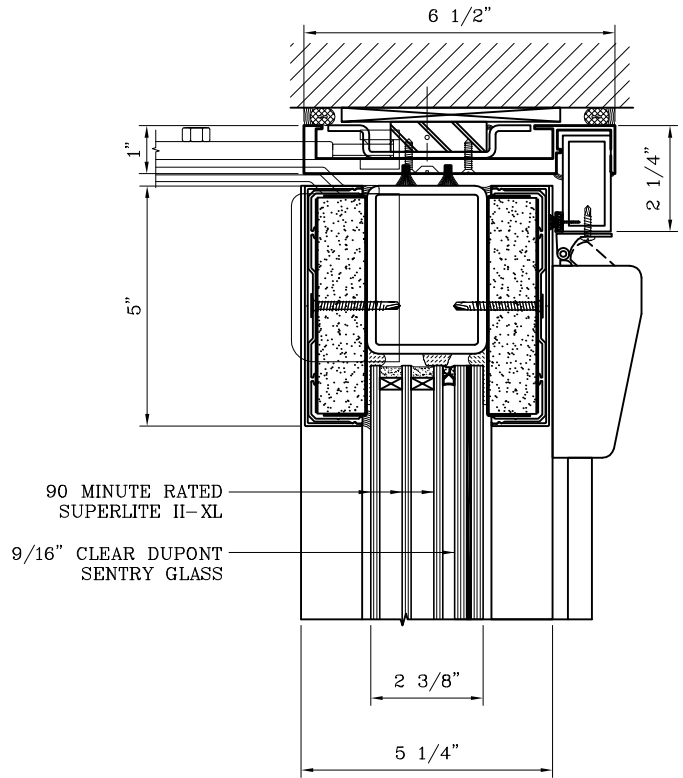

10 DOOR TOP RAIL DETAIL

SAFTIFIRST™
 FIRE RATED GLAZING SOLUTIONS Since 1982
 100 N. HILL DR. SUITE 12 TEL: (415) 824-4900
 BRISBANE, CA 94005 FAX: (415) 824-5900

SuperLite™ II-XL
GPX HURRICANE SYSTEM

DATE:

DRAWN:

SCALE:

These details are subject to change without notice.

90 MINUTE FIRE RESISTIVE HURRICANE RATED SINGLE DOOR

For more details, please visit www.safti.com

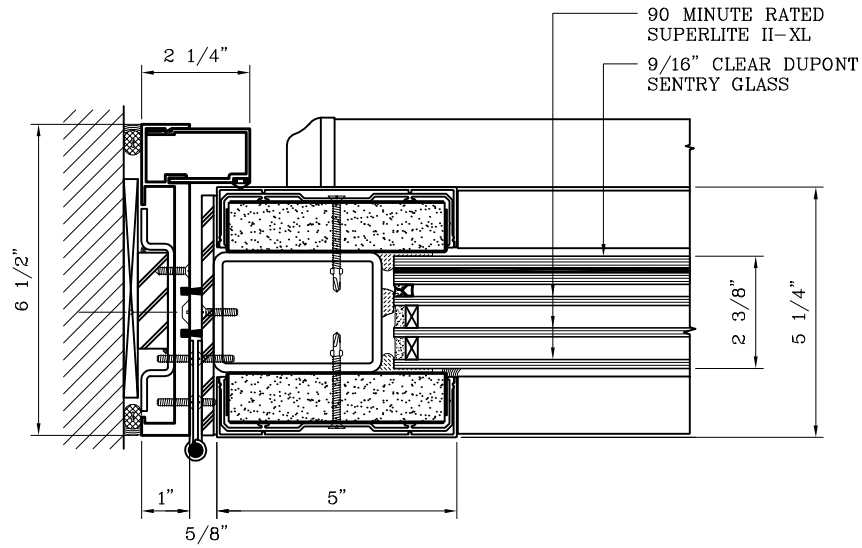

11 DOOR JAMB at HINGE DETAIL

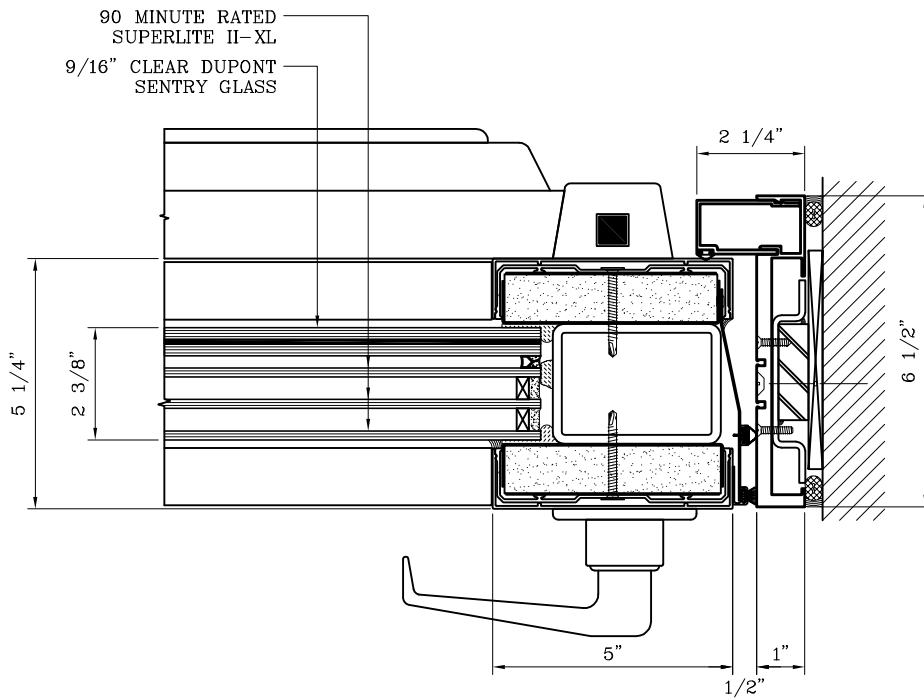

12 DOOR JAMB at LOCK DETAIL

SAFTIFIRST™
 FIRE RATED GLAZING SOLUTIONS Since 1982
 100 N. HILL DR. SUITE 12 TEL: (415) 824-4900
 BRISBANE, CA 94005 FAX: (415) 824-5900

SuperLite™ II-XL
GPX HURRICANE SYSTEM

DATE:

DRAWN:

SCALE:

These details are subject to change without notice.