

60 MINUTE NARROW PROFILE TEMPERATURE RISE DOOR PAIR

—INTERIOR APPLICATION—

For more details, please visit www.safti.com

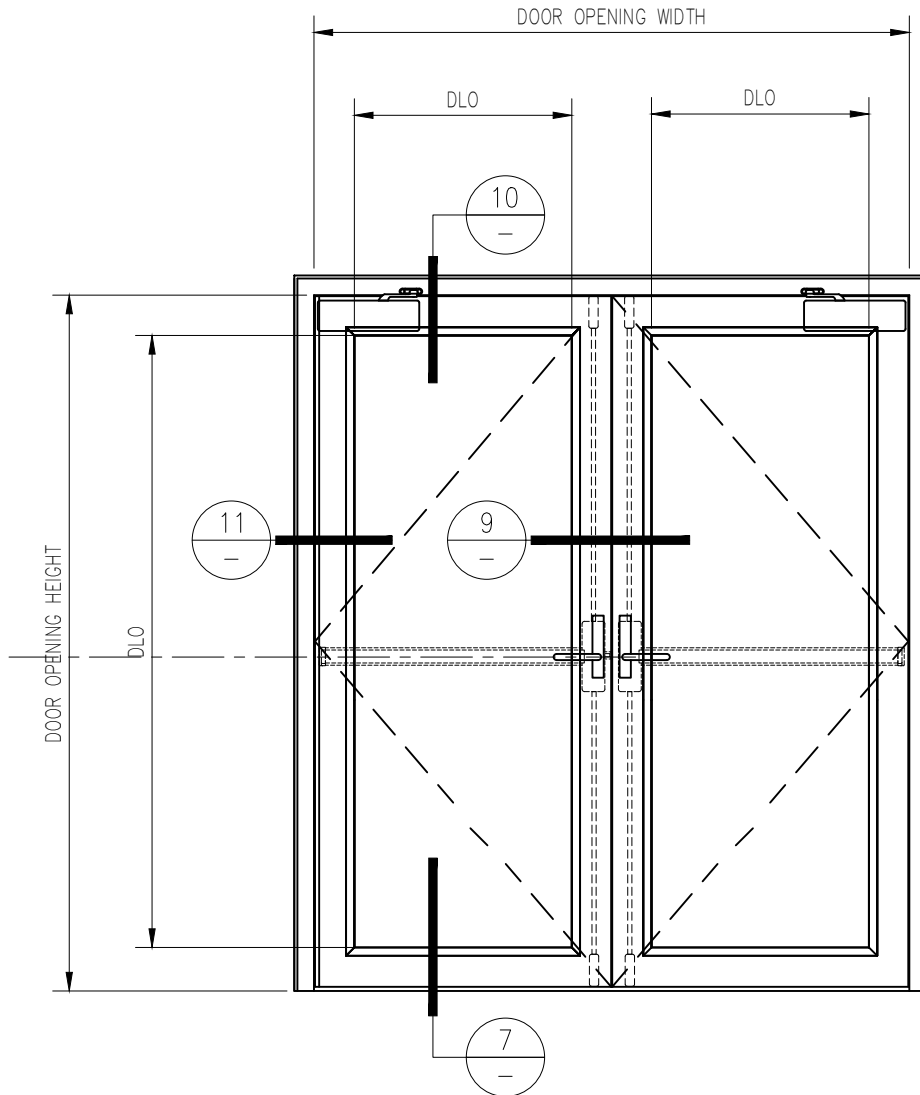

SAFTIFIRST™
FIRE RATED GLAZING SOLUTIONS *Since 1982*
100 N. HILL DR. SUITE 12 TEL: (415) 824-4900
BRISBANE, CA 94005 FAX: (415) 824-5900

SuperLite™ II-XL
GPX BUILDERS SERIES
TEMPERATURE RISE

DATE:

DRAWN:

SCALE:

These details are subject to change without notice.

60 MINUTE NARROW PROFILE TEMPERATURE RISE DOOR PAIR

—INTERIOR APPLICATION—

For more details, please visit www.safti.com

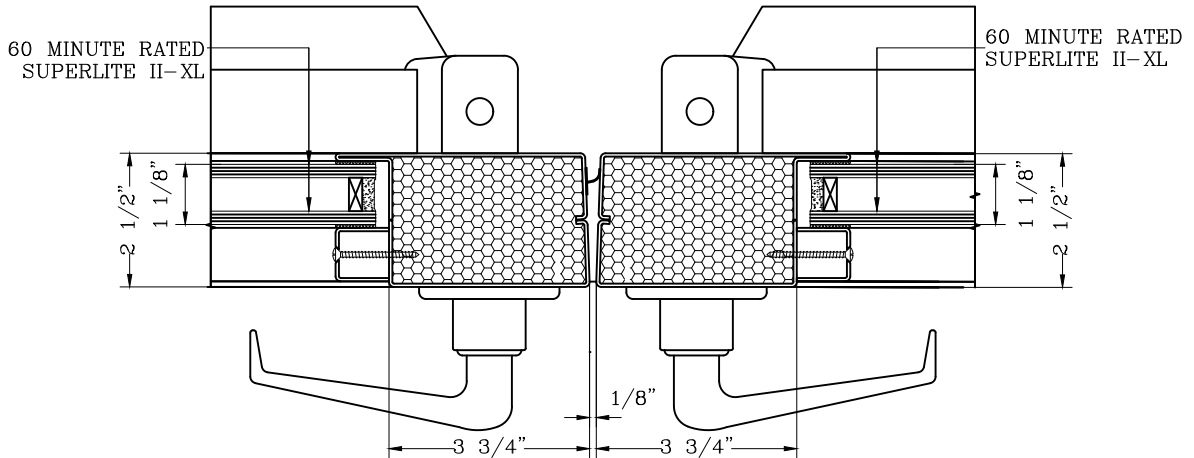
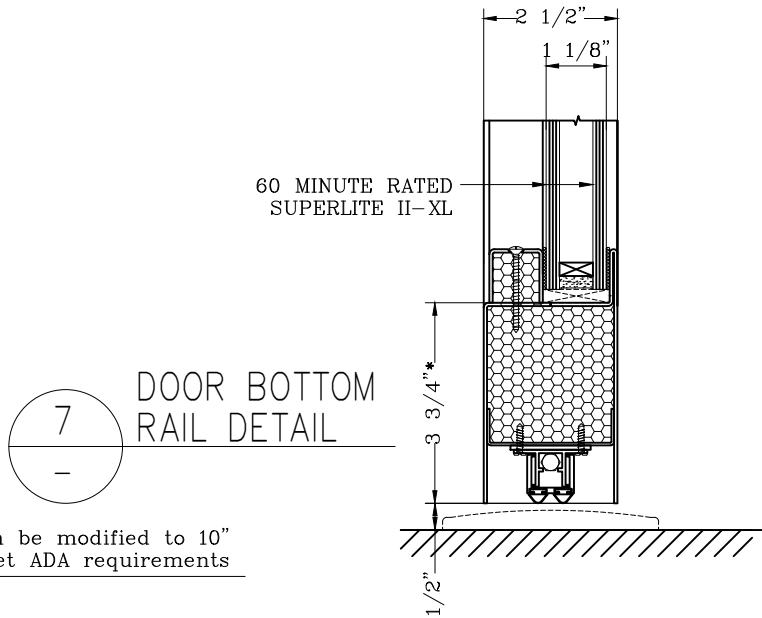

9
—

DOOR MEETING STILES DETAIL

SAFTIFIRST™
 FIRE RATED GLAZING SOLUTIONS Since 1982
 100 N. HILL DR. SUITE 12 TEL: (415) 824-4900
 BRISBANE, CA 94005 FAX: (415) 824-5900

SuperLite™ II-XL
GPX BUILDERS SERIES
 TEMPERATURE RISE

DATE:

DRAWN:

SCALE:

These details are subject to change without notice.

60 MINUTE NARROW PROFILE TEMPERATURE RISE DOOR PAIR

—INTERIOR APPLICATION—

For more details, please visit www.safti.com

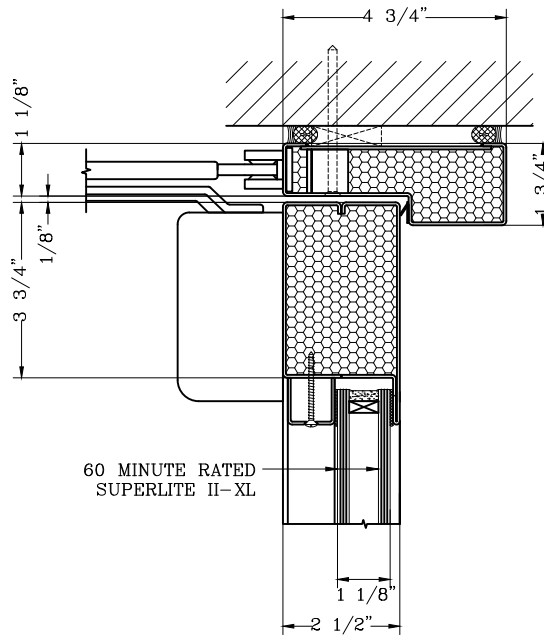

10 DOOR TOP RAIL DETAIL

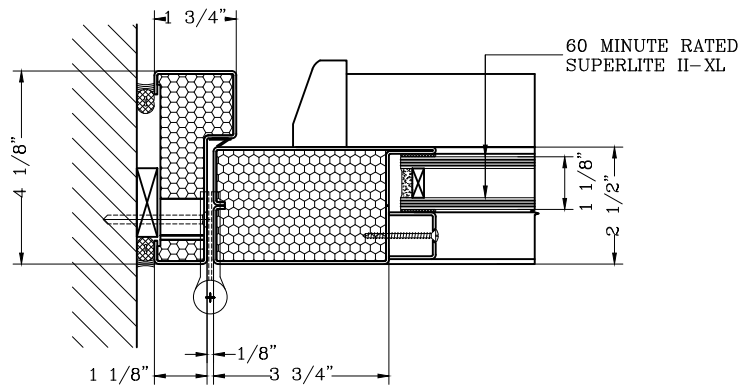

11 DOOR JAMB at HINGE DETAIL

SAFTIFIRST™
 FIRE RATED GLAZING SOLUTIONS *Since 1982*
 100 N. HILL DR. SUITE 12 TEL: (415) 824-4900
 BRISBANE, CA 94005 FAX: (415) 824-5900

SuperLite™ II-XL
GPX BUILDERS
SERIES
 TEMPERATURE RISE

DATE:

DRAWN:

SCALE:

These details are subject to change without notice.