

# 120 MINUTE FIRE RESISTIVE CURTAINWALL WITH 90 MINUTE FIRE RESISTIVE GPX SINGLE DOOR — FOR SPANS OVER 14 FEET —

For more details, please visit [www.safti.com](http://www.safti.com)

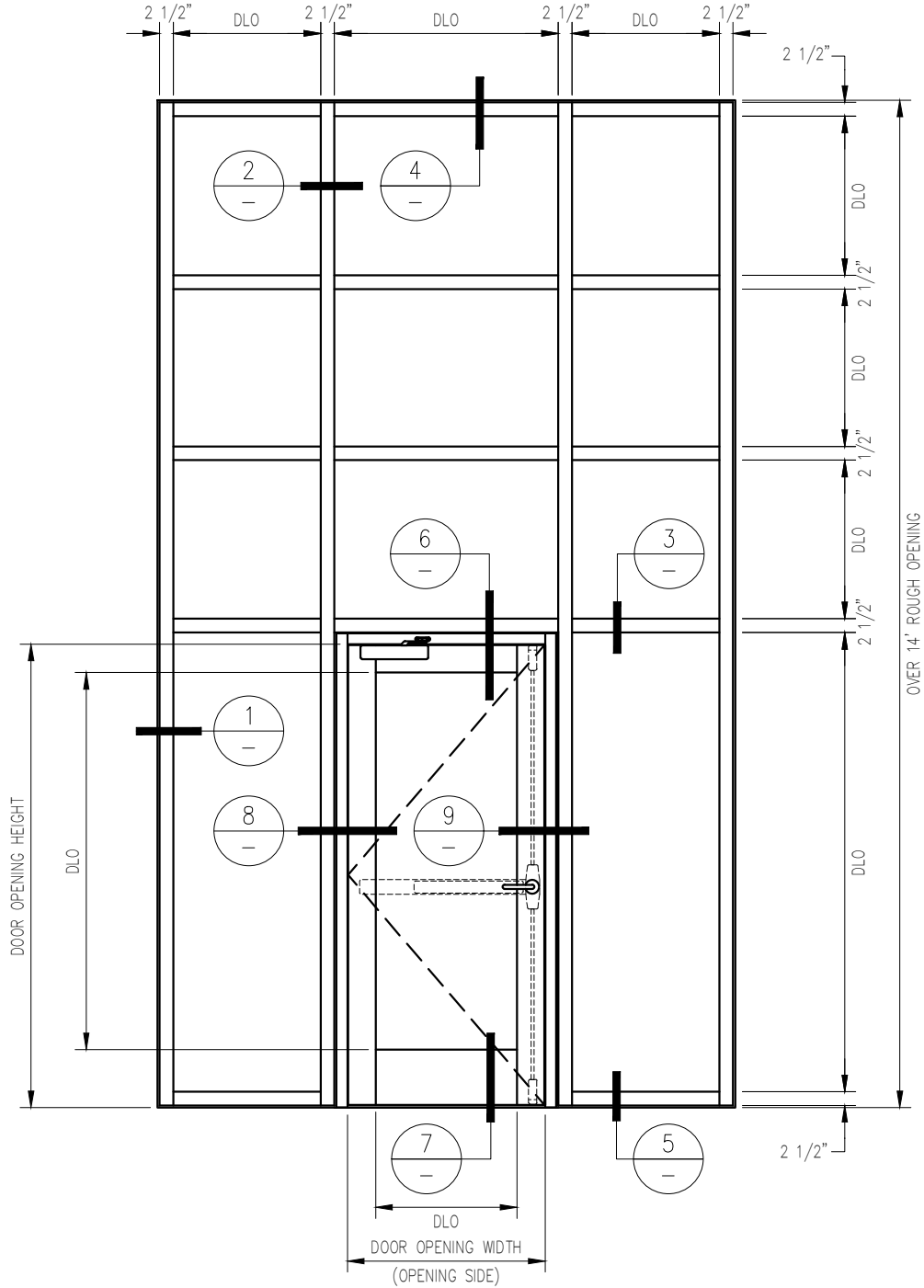

**SAFTIFIRST™**  
 FIRE RATED GLAZING SOLUTIONS *Since 1982*  
 100 N. HILL DR. SUITE 12 TEL: (415) 824-4900  
 BRISBANE, CA 94005 FAX: (415) 824-5900

**SuperLite™ II-XL**  
**GPX CURTAIN WALL SYSTEM**

DATE:

DRAWN:

SCALE:

These details are subject to change without notice.

# 120 MINUTE FIRE RESISTIVE CURTAINWALL WITH 90 MINUTE FIRE RESISTIVE GPX SINGLE DOOR — FOR SPANS OVER 14 FEET —

For more details, please visit [www.safti.com](http://www.safti.com)

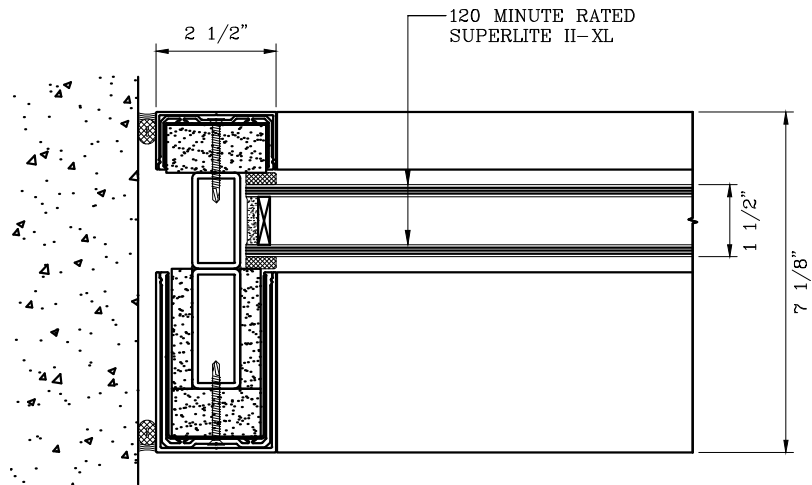

1 JAMB DETAIL

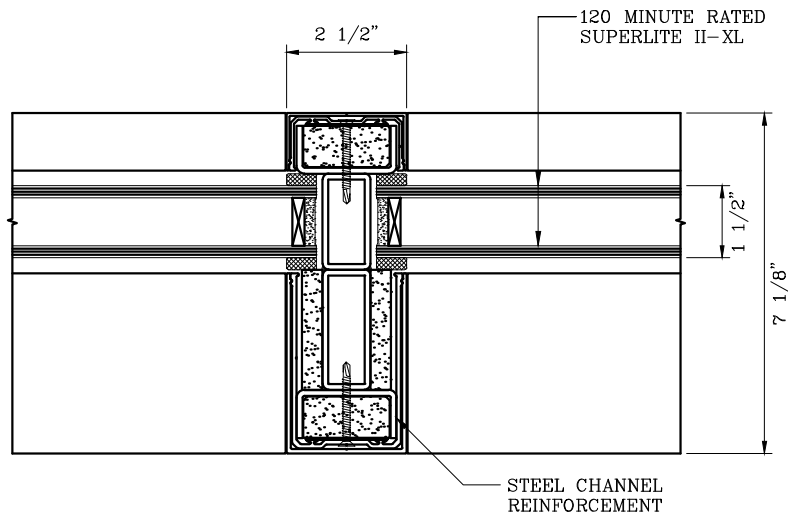

2 VERTICAL MULLION DETAIL

**SAFTIFIRST™**  
FIRE RATED GLAZING SOLUTIONS Since 1982  
100 N. HILL DR. SUITE 12 TEL: (415) 824-4900  
BRISBANE, CA 94005 FAX: (415) 824-5900

**SuperLite™ II-XL**  
**GPX CURTAIN WALL SYSTEM**

DATE:

DRAWN:

SCALE:

These details are subject to change without notice.

# 120 MINUTE FIRE RESISTIVE CURTAINWALL WITH 90 MINUTE FIRE RESISTIVE GPX SINGLE DOOR

— FOR SPANS OVER 14 FEET —

For more details, please visit [www.safti.com](http://www.safti.com)

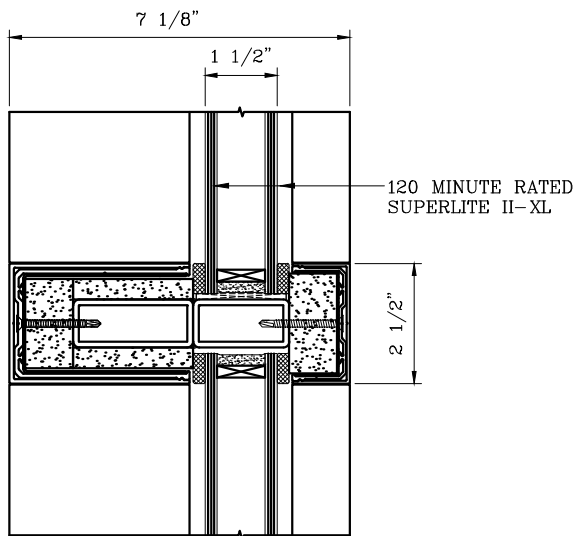

3 HORIZONTAL MULLION DETAIL

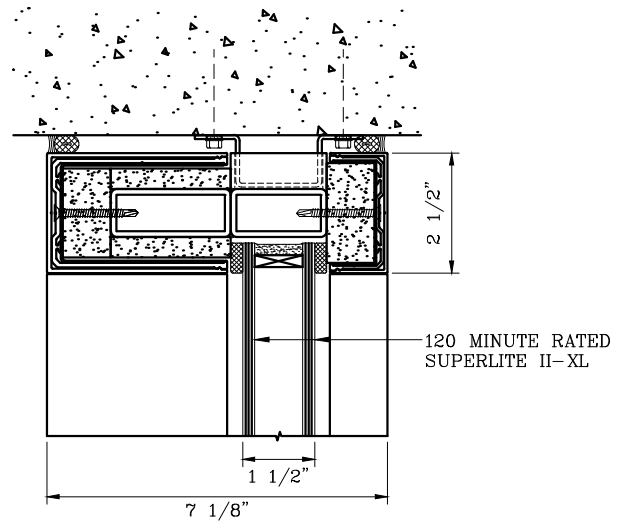

4 HEAD DETAIL

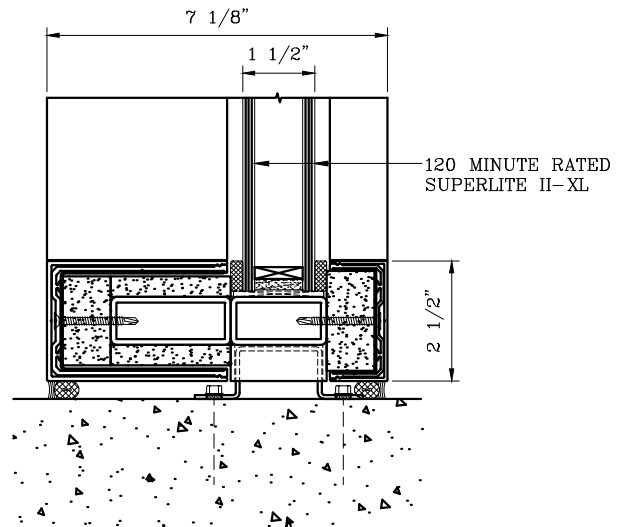

5 SILL DETAIL

**SAFTIFIRST™**  
FIRE RATED GLAZING SOLUTIONS Since 1982  
100 N. HILL DR. SUITE 12 TEL: (415) 824-4900  
BRISBANE, CA 94005 FAX: (415) 824-5900

**SuperLite™ II-XL**  
**GPX CURTAIN WALL SYSTEM**

DATE:

DRAWN:

SCALE:

These details are subject to change without notice.

# 120 MINUTE FIRE RESISTIVE CURTAINWALL WITH 90 MINUTE FIRE RESISTIVE GPX SINGLE DOOR – FOR SPANS OVER 14 FEET –

For more details, please visit [www.safti.com](http://www.safti.com)

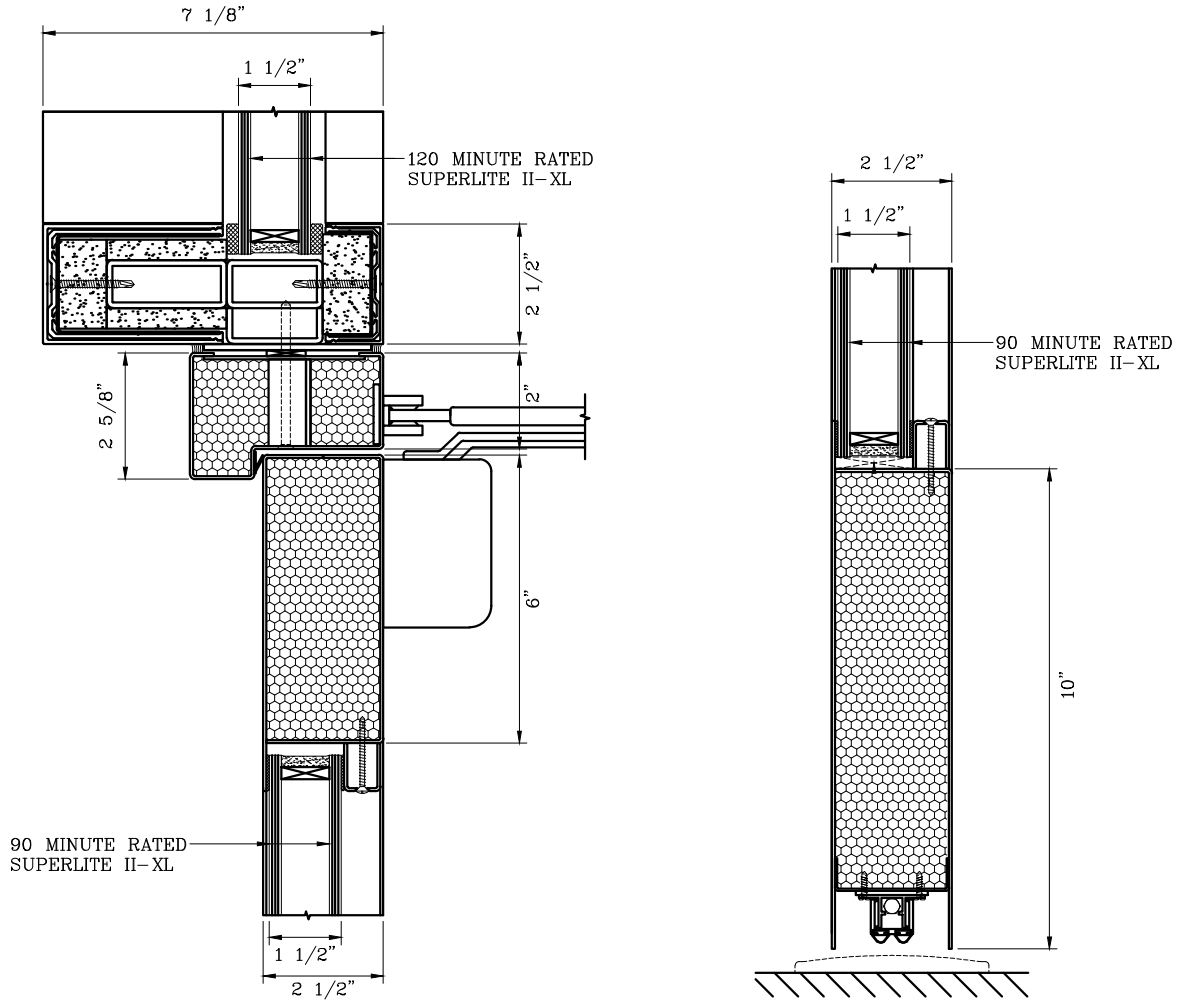

6  
—  
DOOR TOP RAIL DETAIL

7  
—  
DOOR BOTTOM RAIL DETAIL

**SAFTIFIRST™**  
 FIRE RATED GLAZING SOLUTIONS *Since 1982*  
 100 N. HILL DR. SUITE 12 TEL: (415) 824-4900  
 BRISBANE, CA 94005 FAX: (415) 824-5900

**SuperLite™ II-XL**  
**GPX CURTAIN WALL SYSTEM**

DATE:

DRAWN:

SCALE:

These details are subject to change without notice.

# 120 MINUTE FIRE RESISTIVE CURTAINWALL WITH 90 MINUTE FIRE RESISTIVE GPX SINGLE DOOR — FOR SPANS OVER 14 FEET —

For more details, please visit [www.safti.com](http://www.safti.com)

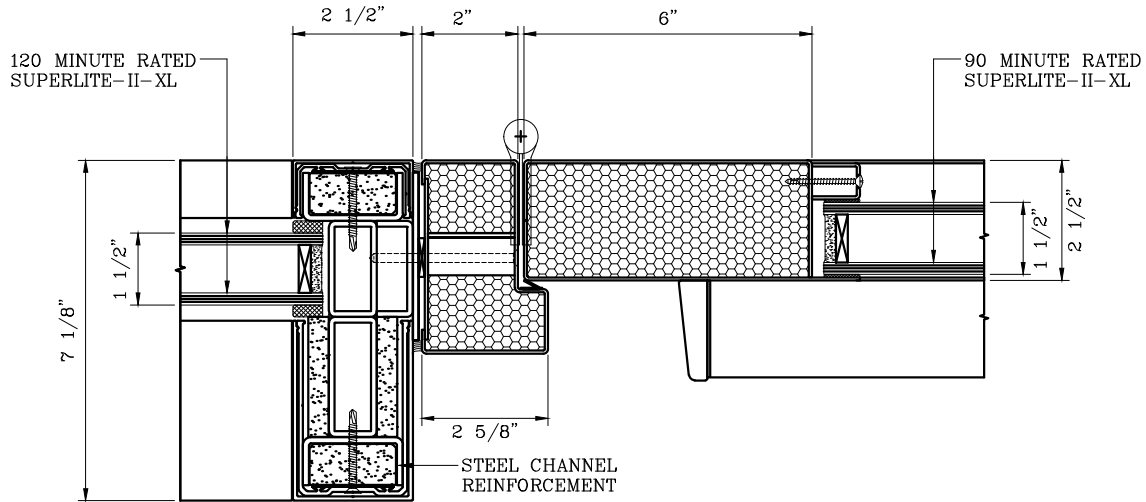

8 DOOR JAMB at HINGE DETAIL

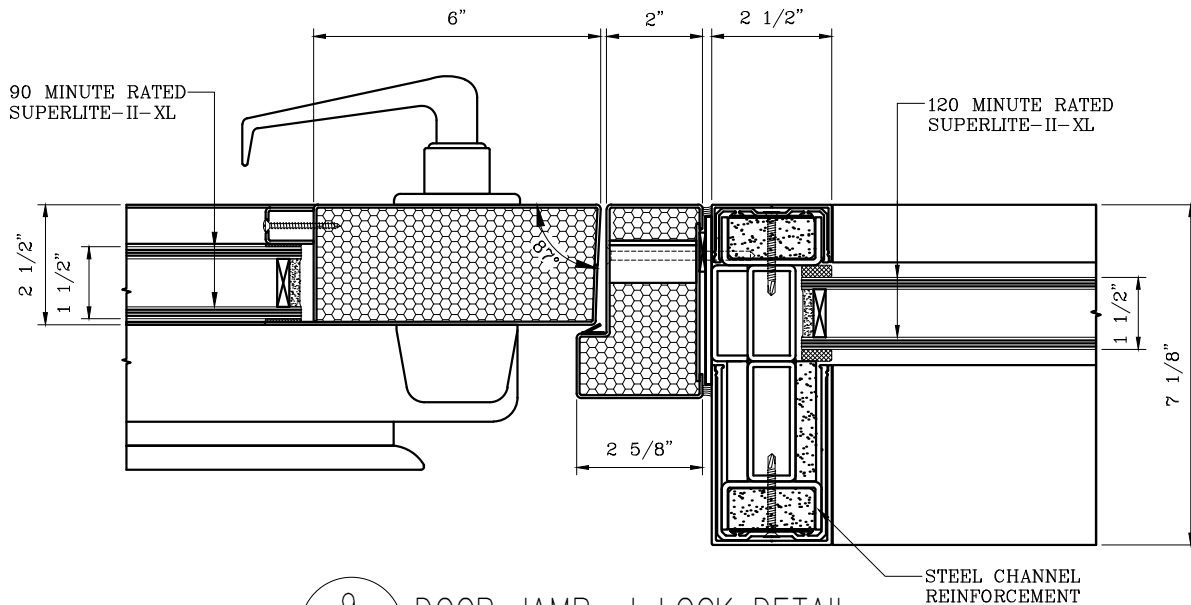

9 DOOR JAMB at LOCK DETAIL

**SAFTIFIRST™**  
FIRE RATED GLAZING SOLUTIONS *Since 1982*  
100 N. HILL DR. SUITE 12 TEL: (415) 824-4900  
BRISBANE, CA 94005 FAX: (415) 824-5900

**SuperLite™ II-XL**  
**GPX CURTAIN WALL SYSTEM**

DATE:

DRAWN:

SCALE:

These details are subject to change without notice.