

# 60 MINUTE FIRE RESISTIVE CURTAIN WALL WITH 60 MINUTE FIRE RESISTIVE GPX PAIR DOOR – FOR SPANS UP TO 14 FEET –

For more details, please visit [www.safti.com](http://www.safti.com)

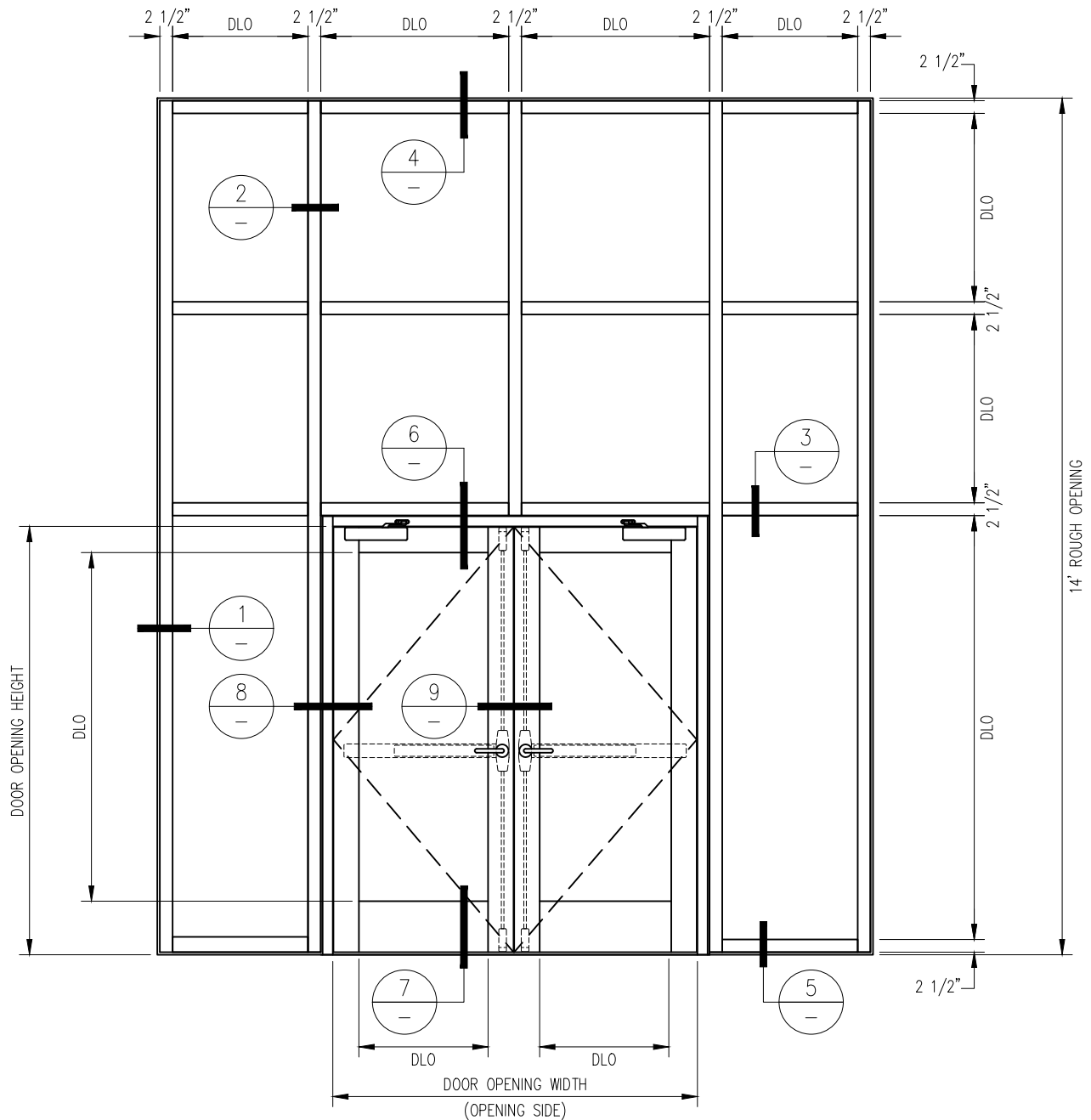

**SAFTIFIRST™**  
FIRE RATED GLAZING SOLUTIONS *Since 1982*  
100 N. HILL DR. SUITE 12 TEL: (415) 824-4900  
BRISBANE, CA 94005 FAX: (415) 824-5900

**SuperLite™ II-XL**  
**GPX CURTAIN WALL SYSTEM**

DATE:

DRAWN:

SCALE:

These details are subject to change without notice.

# 60 MINUTE FIRE RESISTIVE CURTAIN WALL WITH 60 MINUTE FIRE RESISTIVE GPX PAIR DOOR — FOR SPANS UP TO 14 FEET —

For more details, please visit [www.safti.com](http://www.safti.com)

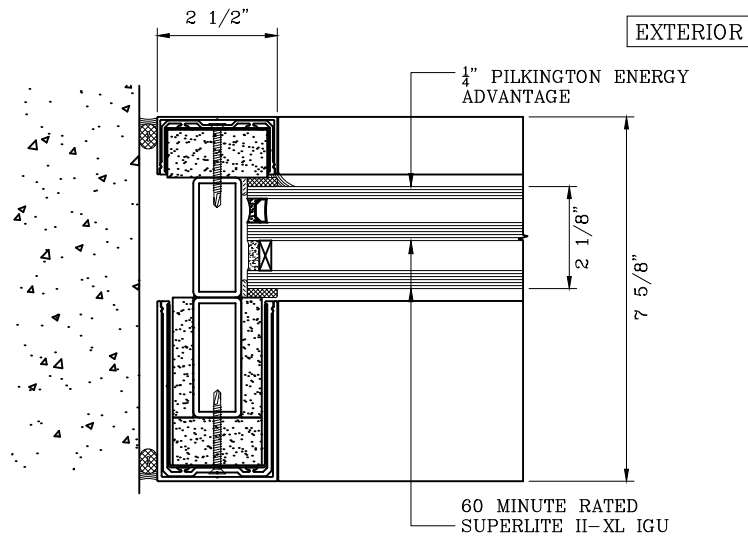

1 JAMB DETAIL

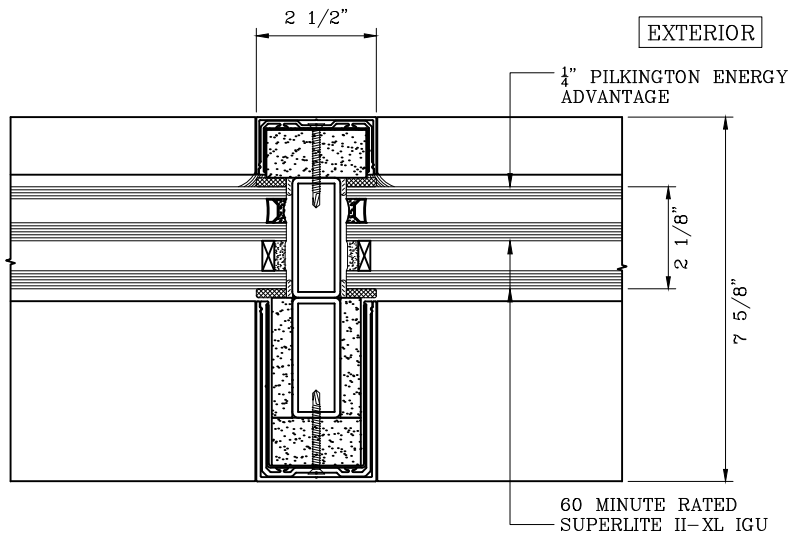

2 VERTICAL MULLION DETAIL

**SAFTIFIRST™**  
FIRE RATED GLAZING SOLUTIONS *Since 1982*  
100 N. HILL DR. SUITE 12 TEL: (415) 824-4900  
BRISBANE, CA 94005 FAX: (415) 824-5900

**SuperLite™ II-XL**  
**GPX CURTAIN WALL SYSTEM**

DATE:

DRAWN:

SCALE:

These details are subject to change without notice.

# 60 MINUTE FIRE RESISTIVE CURTAIN WALL WITH 60 MINUTE FIRE RESISTIVE GPX PAIR DOOR – FOR SPANS UP TO 14 FEET –

For more details, please visit [www.safti.com](http://www.safti.com)

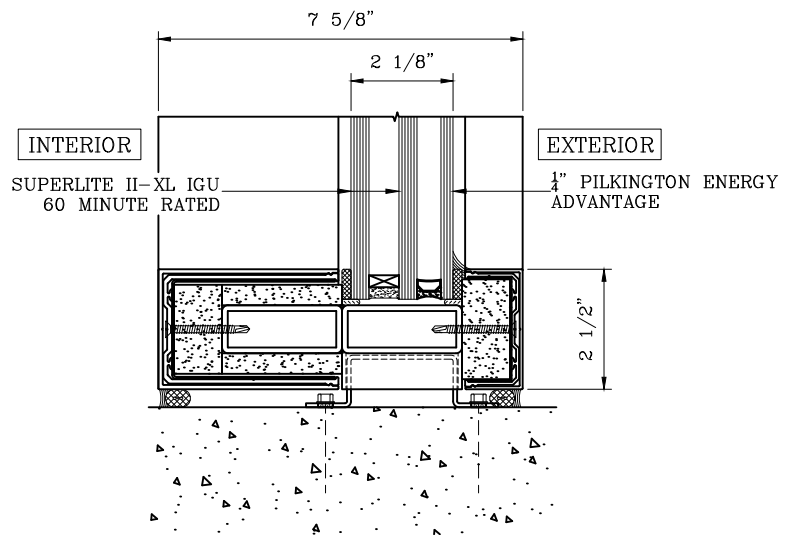
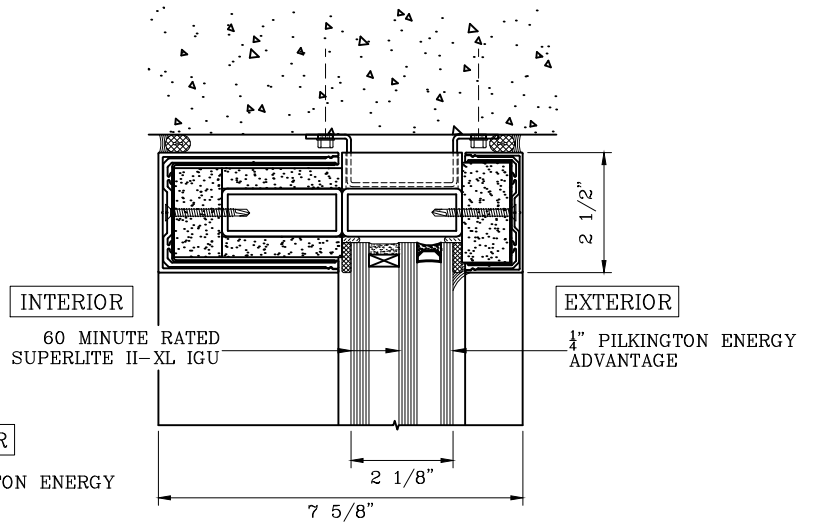
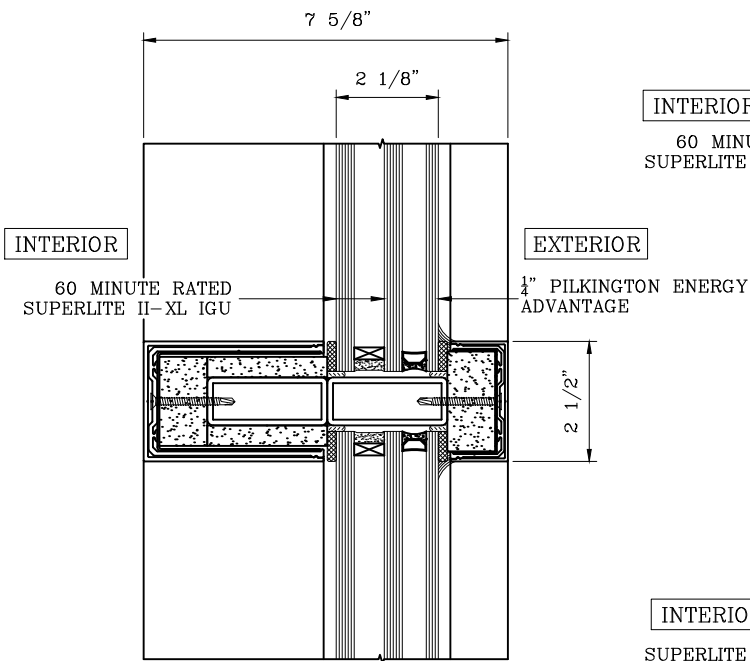

**SAFTIFIRST™**  
FIRE RATED GLAZING SOLUTIONS *Since 1982*  
100 N. HILL DR. SUITE 12 TEL: (415) 824-4900  
BRISBANE, CA 94005 FAX: (415) 824-5900

**SuperLite™ II-XL**  
**GPX CURTAIN WALL SYSTEM**

DATE:

DRAWN:

SCALE:

These details are subject to change without notice.

# 60 MINUTE FIRE RESISTIVE CURTAIN WALL WITH 60 MINUTE FIRE RESISTIVE GPX PAIR DOOR - FOR SPANS UP TO 14 FEET -

For more details, please visit [www.safti.com](http://www.safti.com)

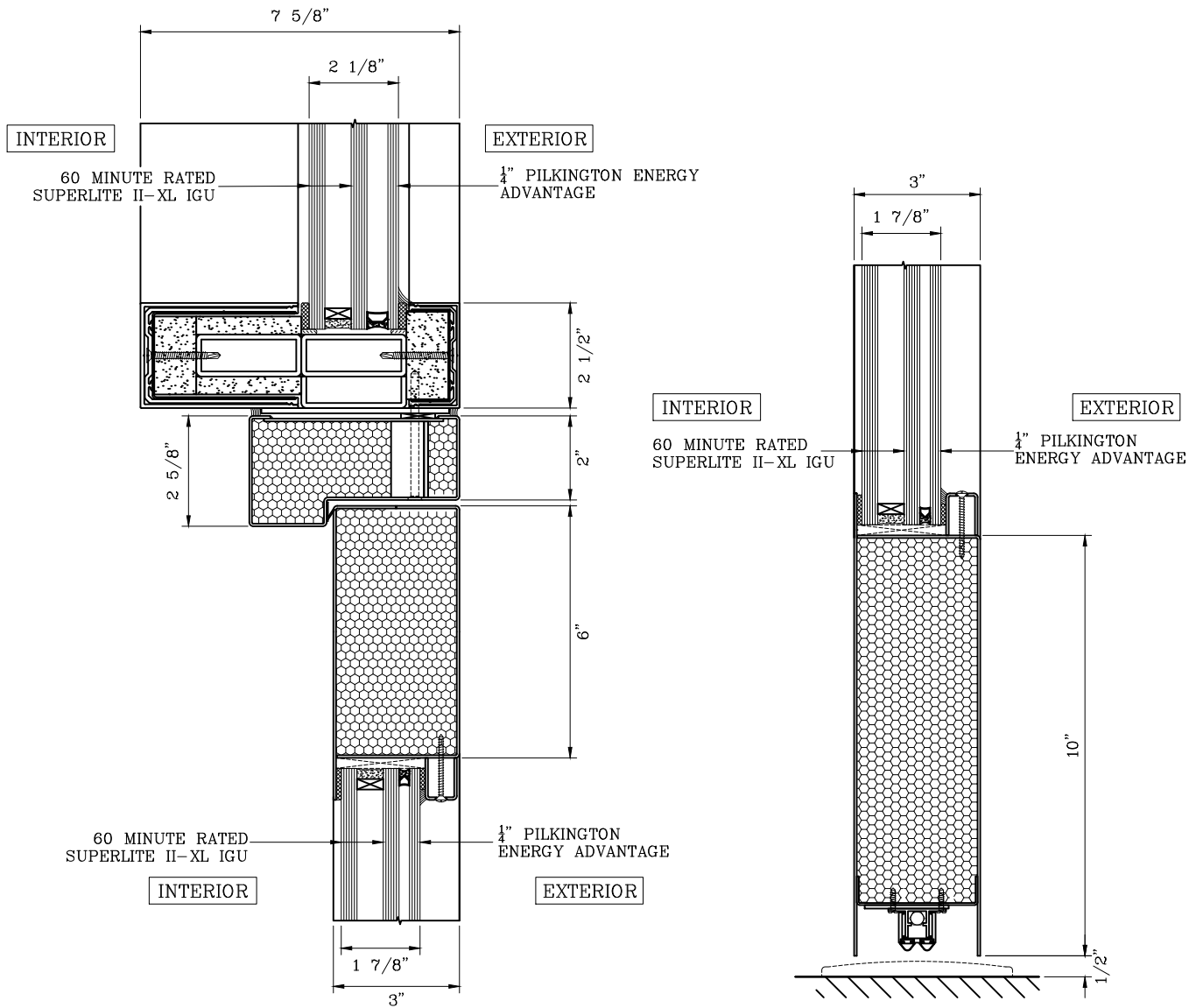

6 DOOR TOP RAIL DETAIL

7 DOOR BOTTOM RAIL DETAIL

**SAFTIFIRST™**  
FIRE RATED GLAZING SOLUTIONS Since 1982  
100 N. HILL DR. SUITE 12 TEL: (415) 824-4900  
BRISBANE, CA 94005 FAX: (415) 824-5900

**SuperLite™ II-XL**  
**GPX CURTAIN WALL SYSTEM**

DATE:

DRAWN:

SCALE:

These details are subject to change without notice.

# 60 MINUTE FIRE RESISTIVE CURTAIN WALL WITH 60 MINUTE FIRE RESISTIVE GPX PAIR DOOR – FOR SPANS UP TO 14 FEET –

For more details, please visit [www.safti.com](http://www.safti.com)

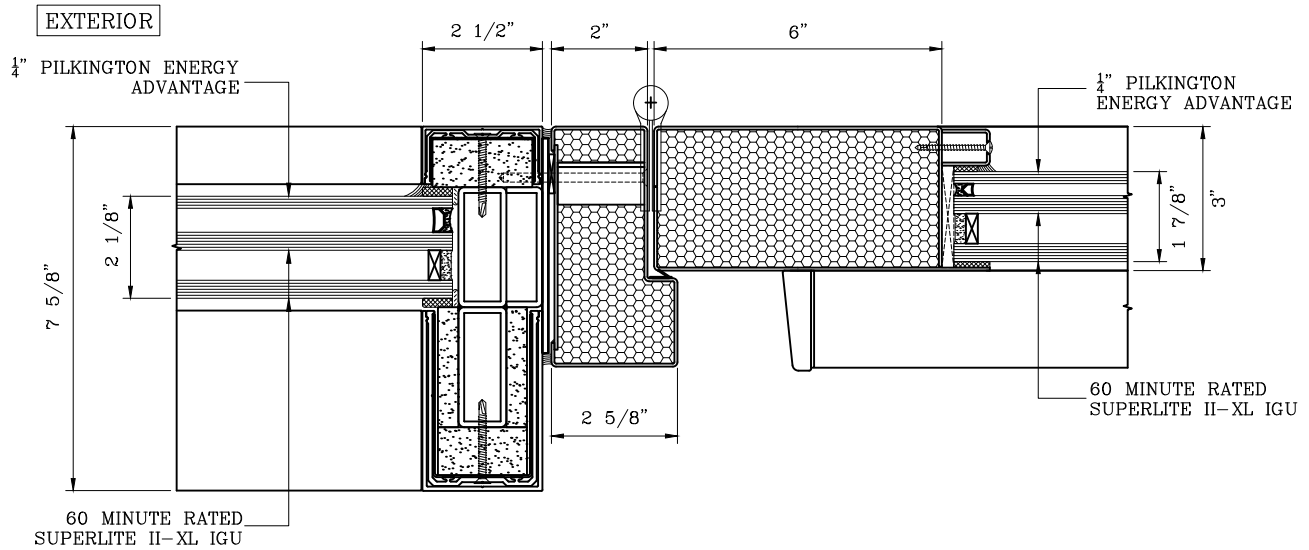

8 DOOR JAMB at HINGE DETAIL

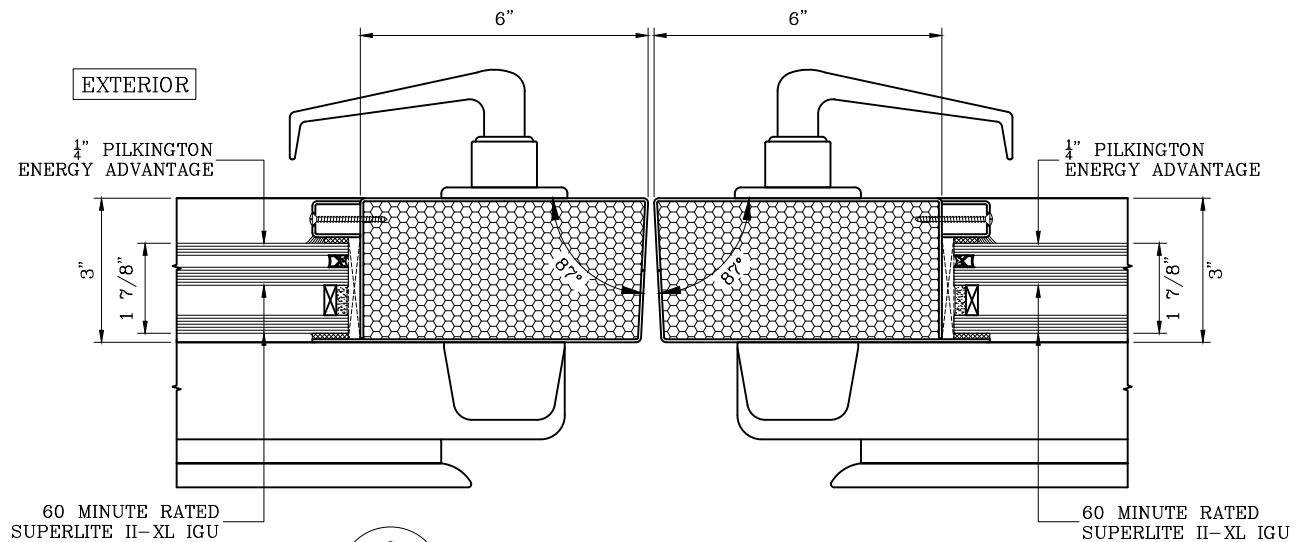

9 DOOR MEETING STILES DETAIL

**SAFTIFIRST™**  
FIRE RATED GLAZING SOLUTIONS Since 1982  
100 N. HILL DR. SUITE 12 TEL: (415) 824-4900  
BRISBANE, CA 94005 FAX: (415) 824-5900

**SuperLite™ II-XL**  
**GPX CURTAIN WALL SYSTEM**

DATE:

DRAWN:

SCALE:

These details are subject to change without notice.